

NORTH AMERICAN FLYBALL ASSOCIATION, INC.®

OFFICIAL RULES OF RACING, CORPORATE

POLICIES AND BY-LAWS

October 1, 2010



Copyright January 1985 through 1991 by Michael F. Randall, Revised 1992 through 2009, by the North American Flyball Association, Inc.® All rights reserved. No part of this publication may be reproduced or transmitted in any form or by any means without permission from the North American Flyball Association, Inc.®, except by a reviewer who wishes to quote brief passages in connection with a review for the inclusion in a magazine, newspaper, broadcast or for the purpose of training students under their direction.

NAFA®, the NAFA logo and North American Flyball Association® are registered trademarks of NAFA, Inc.

Flyball got its start in the 1970's when Californian Herbert Wagner developed the first tennis ball launcher. Subsequently, the new sport for dog enthusiasts was introduced in the Toronto - Detroit area by several dog training clubs. After a few small tournaments were held in conjunction with dog shows, the first ever Flyball tournament was held in 1983.

Flyball races match two teams of four dogs each, racing side-by-side over a 51 foot long course. Each dog must run in relay fashion down the jumps, trigger a Flyball box, releasing the ball, retrieve the ball, and return over the jumps. The next dog is released to run the course but can't cross the start/finish line until the previous dog has returned over all 4 jumps and reached the start/finish line. The first team to have all 4 dogs finish the course without error wins the heat.

To standardize the rules, keep records of tournaments, and guide the development of Flyball racing, the North American Flyball Association, Inc.® (**NAFA®**) was formed in 1985 by a group representing 12 teams from Michigan and Ontario. Interest and participation in Flyball has soared since its beginning and is now enjoyed throughout North America, Europe, Australia, and other countries. NAFA® has over 700 registered clubs with more than 16,000 registered dogs.

Flyball races offer fast paced action with plenty of excitement for dogs, handlers, and especially spectators. Many teams run all 4 dogs through the course in less than 20 seconds while the NAFA® record now approaches 15 seconds. NAFA® tournaments are divided into divisions so that teams compete against other teams of equal abilities. All dogs including mixed breeds are eligible to compete and earn titles in NAFA® sanctioned tournaments. Titles are earned via a point system based on the time it takes a dog's team to complete each heat race.

The NAFA® Rules and Policies document consists of the Rules of Racing, the Corporate Policies and Procedures and NAFA® By-laws for Flyball racing at NAFA® sanctioned Tournaments

List of Significant Changes or Additions for the 2011 Racing Year

Rules of Racing

1. *Section 1.1 Flyball Boxes (e)(v) – amended to* “The box shall not exceed these dimensions at any time during the heat (including any attachments to the box, e.g. carrying handles, cooking devices, or flaps/shields/wings). The box loader may not change the configuration of the box during the heat except as needed to load the ball or to straighten the box if it has shifted during the heat. If the box exceeds these dimensions at any time during the heat the team shall be awarded a “No Finish.” Judges have the discretion to declare a box unsafe and therefore not usable.”
2. *Section 1.2 Balls – amended to* “Each club shall have a supply of round balls subject to the size, safety, and comfort of the dogs. Approved balls to be retrieved from the box may be any color, must bounce when dropped onto a hard surface, must roll, and must perform as required per Chapter 1 Section 1.1(d). Balls may not contain a noise maker, e.g. bells or squeakers.”
3. *Section 2.4 Ring Layout – amended to* “.... The length of the racing lane shall include an area not less than 50 feet leading up to the start/finish line and an area behind the box line and in front of the backstops to a minimum of 5 feet and that the backstops may protrude up to 2 feet in front of the box line. For tournaments held in venues that will not accommodate 50 feet of run back, the tournament director may apply for an exception from the Executive Director if adequate notice is given to teams and appropriate safety measures are put in place. If the Executive Director grants an exception, the tournament will not count for regional points

No equipment or other items may be between the racing lanes from the backstop to the start/finish line except those needed for utilizing the electronic judging system.”
4. *Chapter 3 Teams and Timesheets (c) – amended to* “...does not in any way assist the dogs in navigating the course or violate the rules.”
5. *Chapter 3 Teams and Timesheets (e) – amended to ensure that dogs cannot race on more than two teams per day.*
6. *Chapter 3 Teams and Timesheets (h) – amended to add* Failure to record a jump height for a dog on the C.2 timesheet alone does not trigger the penalty specified in Section 7.6 and does not require forfeiting of the heats.
7. *Chapter 4 – Measuring – added* ...In the event a team has failed to record the dog’s jump height on the C.2 timesheet and the dog fails the jump height challenge, it will be presumed that the team was jumping the incorrect height in all preceding heats where the dog was circled.
8. *Section 8.3 (a) – amended to* “... Each dog is to hurdle the four jumps in succession, trigger the box, releasing the ball, retrieve the ball, and return over all four jumps and the start/finish line with the ball in its mouth.”
9. *Section 8.1 Tournament Seeding/Breakout Rule amended to have the time recorded for completed breakout heats so that NAFA points can be awarded.*
10. *Section 8.3 (e) – amended to* “..... the box loader must remain in the upright position behind the box, and may offer verbal encouragement only, as long as such encouragement does not distract the opposing team. For deaf dogs, box loaders should be permitted to use a subtle hand signal as long as it does not interfere with other competitors. As a courtesy to opposing teams, the box loader is to remain in position until the outcome of the heat is determined by the Head Judge. If, in the judge's opinion, a box loader has violated any of the set rules, their team may forfeit the heat.”
11. *Section 8.3 (k) – amended to Intervention.* Should the ball bounce back in the cup as the dog tries to catch it, the box loader may re-set the box for the dog to trigger it (without penalty). For deaf

dogs, box loaders should be permitted to use a subtle hand signal as long as it does not interfere with other competitors. This is- These are the only times_ at which the box loader is permitted to signal a dog to push the pedal.

12. *Section 8.4 Aggressive Dogs, amended as follows:*The Head Judge must report any dog excused from competition ~~to the Executive Director on NAFA® Form C-12.~~ utilizing the procedures set forth in Section 5.7 of the Corporate Policies and Procedures.

13. added a new Section 8.7

Section 8.7 – Racing without EJS (Electronic Judging System)

Glossary

14. *Glossary - added " Racing lane – The racing lane extends from the backstop behind the box, through the course, through the start finish line, to the point where the racing surface (grass, matting, etc.) no longer extends at least 4.5 feet on either side of the racing lane center line. See also the diagram in Section 2.4 – Ring Layout.*
15. *Glossary – added " Runback – That area of the racing lane leading up to the start finish line, before the course, which consists of the racing surface (grass, matting, etc.) a minimum of 4.5 feet on either side of the racing lane center line. This distance is required on the sanctioning form to sanction an event.*

Corporate Policies and Procedures

16. Section 1.2, Tournament Sanctioning Secretary, amended

17. *Chapter 2 Judges (f) – amended to "(f) A judge is allowed to make a reasonable accommodations and/or exceptions to the Rules of Racing for the needs of a handicapped dog and/or handler so long as these accommodations do not interfere with other competitors. For deaf dogs, box loaders should be permitted to use a subtle hand signal as long as it does not interfere with other competitors.*

18. *Section 5.1 Code of Ethics (d) – amended Misconduct shall include, but not be limited to, abusive or foul language, demonstration of dissatisfaction with a judge's decision, inhumane treatment of a dog, racing a dog who is not in adequate physical condition for the number of heats the dog is asked to run, demonstration of poor sportsmanship, willful violation of the rules with the intent to gain an unfair advantage, or any other behavior or altercation that would leave a spectator or exhibit or with an unfavorable opinion of Flyball.*

19. *Section 5.1 (g) – amended Regional Directors should warn teams and file unsportsmanlike conduct charges if teams are obviously and repeatedly holding back their dogs in tournaments "to gain an unfair advantage."*

20. *Section 6.1 (k) – added:*

(iv) If any limited class in an event requires a draw, then all limited classes in that event must be drawn.

(v) If the Executive Director determines that the draw was completed incorrectly, then the draw for the entire event will be repeated.

21. Section 6.1 (l), modified:(l) Prize money for any one team may not exceed \$500.00 USD or \$600.00 CDN per event per day. ~~In addition, a host or sponsor may offer expense money provided the same is distributed fairly among all participating teams, based on actual expenses.~~

22. Section 6.1 (m) –Section 6.1 (m) - Amended to accommodate electronic submission of results, new fees and the requirement that Clubs retain C.2 timesheets or a period of one year following their tournament.

23. *Section 6.1 (o) – amended to “Any tournament sanctioned by NAFA® must use a NAFA® approved Head Judge at the provisional level or higher.”*
24. *Section 6.2 – Classes of Competition – redrafted to treat non-regular classes consistently and to ensure that dogs cannot race on more than two teams per day.*
25. *Section 7.5 – Changing Clubs, amended subsection (c) as follows:*
- (v) Other Classes or Time Sheets. A dog that is listed on a timesheet for a Performance Team may be listed on the timesheet for one additional team provided the entry is on a team in another class, except in circumstances where a second entry would be prohibited by Sections 6.2(f), (g), or (h) of the NAFA® Policies and Procedures.
26. *Section 7.6 – added “failure to record a height on a C.2 form alone does not trigger the penalty specified in Section 7.6 and does not require forfeiting of the heats.”*
27. *Section 8.1 – Tournament Seeding/Break-out Rule, amended:*
- Tournaments will be seeded by the times submitted with the team’s entry. After the closing date, the tournament director will divide the entered teams into divisions. Each division’s break-out time will be one (1) second faster than the top team’s seed time. Except in Division 1, a team running more than one (1) second faster than the top team’s seed time will “breakout” of the division and will be declared the loser of the heat. ~~and will not be awarded NAFA® Points.~~ If the Electronic Judging System fails, this rule does not apply. **NOTE:** Tournament time sheets should be marked BO and indicate a loss, but a time must be included so points may be calculated., show no time, and indicate a loss.
- i. A team that breaks out three (3) times in a tournament is ineligible for any tournament placement. NAFA® points are still awarded for completed heats, non break-out times; ~~In the event both teams in a heat break-out, both teams will be awarded a loss and no NAFA® points awarded;~~
28. *Section 8.3 Regional Champions (f) – amended “...When regional points are not awarded due to a Club’s prior win in the same week, the points will not be awarded to teams finishing lower in the tournament....”*
29. *Section 8.5 Clyde Moore Memorial Hall of Fame, amended:*
- Submit nominations to NAFA® no earlier than June 1st and no later than July 31st of each year. ~~by mailing to the Hall of Fame Committee at the published NAFA® address.~~ Nominations may be submitted by mail, fax, or electronically.
30. *Section 8.6 Regional MVP Award*
- ~~Nominations should be sent to the NAFA® mailing address. Submit nominations to NAFA® no earlier than June 1st and no later than July 31st of each year by mailing to the Hall of Fame Committee at the published NAFA® address.~~ Submit nominations to NAFA® no earlier than June 1st and no later than July 31st of each year. Nominations may be submitted by mail, fax, or electronically.
31. *Section 8.7 – Added Judge of the Year Award*

Bylaws

Substantially redrafted effective October 1, 2010.

Appendix A – Schedule of Fees

Updated effective October 1, 2010.

Appendix B - Forms

1. *Form C.6* - Modified to comply with new rules for sending electronic results, update the address for submission of results, and to reflect new fee of \$30/\$35 for tournaments held over more than one day.
2. *Form C.17* – Amended to indicate, “Satisfactory Completion of Assignment” and “Do Not Recommend.”
3. *Form C.18* – Amended to fix typographical error.
4. *Form C.18* – Amended as *C.17* above and to include space for name of Tournament Director and Regional Director
5. All judge re view forms modified to include a section for “strengths” and “ areas for continued improvement.”
6. Forms modified to update NAFA mailing address and email address.

Appendix C – Racing Schedules

5, 7 & 8 team single elimination brackets were revised and replaced.

Table of Contents

RULES OF RACING.....	1
CHAPTER 1 - EQUIPMENT	2
Section 1.1 - Flyball Boxes	2
Section 1.2 - Balls	3
Section 1.3 - Collars	3
CHAPTER 2 - RING SET-UP	3
Section 2.1 - Footing	3
Section 2.2 - Barriers.....	3
Section 2.3 - Jumps	3
Section 2.4 - Ring Layout.....	4
CHAPTER 3 - TEAMS AND TIMESHEETS	5
CHAPTER 4 - MEASURING	6
CHAPTER 5 - JUDGES	8
CHAPTER 6 - REPORTING FOR RACES.....	9
CHAPTER 7 - WARM-UPS.....	9
CHAPTER 8 - RULES OF RACING	10
Section 8.1 - Tournament Seeding/Breakout Rule	10
Section 8.2 - Jump Heights.....	10
Section 8.3 - The Heat.....	10
Section 8.4 - Aggressive Dogs	13
Section 8.5 - Condition of Dogs.....	13
Section 8.6 - Race Results	13
Section 8.7 - Racing without the Electronic Judging System (EJS).....	13
CORPORATE POLICIES & PROCEDURES	17
CHAPTER 1 – EXECUTIVE DIRECTOR STAFF.....	18
Section 1.1 – Statistician	18
Section 1.2 – Tournament Sanctioning Secretary	18
Section 1.3 – Webpage.....	18
Section 1.4 – EJS Coordinator	18
Section 1.5 – Webmaster.....	18
Section 1.6 – Regional Directors.....	19
CHAPTER 2 – JUDGES.....	19
CHAPTER 3 – ANNUAL GENERAL MEETING	22
CHAPTER 4 – DELEGATE VOTES.....	22
CHAPTER 5 – CODE OF CONDUCT	22
Section 5.1 – Code of Ethics	22
Section 5.2 – Discipline.....	23
Section 5.3 - Pre-hearing	23

Section 5.4 - Hearing.....	24
Section 5.5 - Post-Hearing.....	24
Section 5.6 - Probation.....	25
Section 5.7 - Aggressive Dogs.....	25
Section 5.8 – Publishing of Disciplinary Action.....	26
CHAPTER 6 – HOSTING A NAFA® SANCTIONED EVENT.....	26
Section 6.1 – Requirements.....	26
Section 6.2 - Classes of Competition.....	30
Section 6.3 – Format & Schedule.....	31
Section 6.4 - Seeding.....	32
Section 6.5 – Electronic Judging Systems.....	32
CHAPTER 7 – STANDING RULES OF COMPETITION.....	33
Section 7.1 – Height Cards.....	33
Section 7.2 – Record Times.....	35
Section 7.3 – Racing Year.....	35
Section 7.4 – Meaningless Heats.....	36
Section 7.5 – Changing Clubs.....	36
Section 7.6 – Penalties for Ineligible Dogs Running.....	37
CHAPTER 8 – AWARDS.....	37
Section 8.1 - Points.....	37
Section 8.2 - Titles.....	38
Section 8.3 - Regional Champions.....	38
Section 8.4 – NAFA® Champions.....	40
Section 8.5 – Clyde Moore Memorial Hall of Fame.....	40
Section 8.6 – Regional MVP Award.....	41
Section 8.7 – Judge of the Year Award.....	42
CHAPTER 9 - CONFLICT OF INTEREST POLICY.....	42
BYLAWS.....	43
ARTICLE I - OFFICES.....	44
ARTICLE II - PURPOSE.....	44
ARTICLE III - MEMBERSHIP.....	44
ARTICLE IV - BOARD OF DIRECTORS.....	44
Section 1. Powers.....	44
Section 2. Number.....	44
Section 3. Eligibility.....	44
Section 4. Election of Directors.....	44
Section 5. Term of Office.....	44
Section 6. Vacancies.....	45
Section 7. Annual Meeting.....	45
Section 8. Regular Meetings.....	45
Section 9. Special Meetings.....	45
Section 10. Open Meetings.....	45
Section 11. Notice: Waiver of Notice.....	45
Section 12. Quorum and Vote at Meetings.....	45
Section 13. Executive Session.....	45
Section 14. Telephone Meetings.....	45
Section 15. Action by Unanimous Consent.....	46

Section 16. Resignation and Removal of Directors	46
Section 17. Compensation and Reimbursement	46
Section 18. Minutes	46
Section 19. Conduct of Meetings	46
ARTICLE V - COMMITTEES OF DIRECTORS	46
Section 1. Committees	46
Section 2. Standing Committees.....	46
Section 3. Tenure.....	47
Section 4. Meeting and Notices.....	48
Section 5. Quorum.....	48
Section 6. Action By Unanimous Consent and Telephone Meetings	48
Section 7. Removal and Resignations.....	48
Section 8. Vacancies	48
Section 9. Reports.....	48
ARTICLE VI - OFFICERS.....	48
Section 1. Positions.....	48
Section 2. Election, Term of Office and Vacancies	48
Section 3. Chairperson of the Board	48
Section 4. Executive Director.....	49
Section 5. Vice-Chairperson.....	49
Section 6. Secretary	49
Section 7. Treasurer	49
Section 8. Bond	50
Section 9. Authority for Expenditures	50
Section 10. Indemnification	50
ARTICLE VII - AFFILIATE CLUBS AND DELEGATES.....	50
Section 1. Local Organizations.....	50
Section 2. Delegate Vote Calculations.....	50
Section 3. Rules Governing Delegate Voting.....	51
Section 4. Annual General Meeting.....	51
Section 5. Delegate Action.....	51
ARTICLE VIII - GENERAL PROVISIONS	52
Section 1. Seal	52
Section 2. Fiscal Year	52
Section 3. Legal Construction	52
ARTICLE IX - AMENDMENTS TO BYLAWS.....	52

NORTH AMERICAN FLYBALL ASSOCIATION, INC.®

RULES OF RACING

CHAPTER 1 - EQUIPMENT

Section 1.1 - Flyball Boxes

- (a) Each team shall supply a Flyball box.
- (b) All boxes are to have a mechanical (not electrical) mechanism.
- (c) The boxes may be painted or decorated as the team wishes.
- (d) The ball, when released, must have a free unobstructed flight of not less than 24 inches from the point that the ball is released, in the direction of the start/finish line from all holes.
- (e) Boxes:
 - (i) Shall not exceed 24 inches in width, nor 18 inches in height from the bottom surface of the box excluding mat grabbing devices/materials and outdoor staking devices;
 - (ii) The body of the box shall not exceed 30 inches in depth;
 - (iii) The base of the box upon which the boxloader stands may exceed 30 inches in depth;
 - (iv) Mat grabbing devices/materials shall not raise the box by more than one half inch;
 - (v) The box shall not exceed these dimensions at any time during the heat (including any attachments to the box, e.g. carrying handles, cocking devices, or flaps/shields/wings).The boxloader may not change the configuration of the box during the heat except as needed to load the ball or to straighten the box if it has shifted during the heat. If the box exceeds these dimensions at any time during the heat the team shall be awarded a "No Finish". Judges have the discretion to declare a box unsafe and therefore not usable.

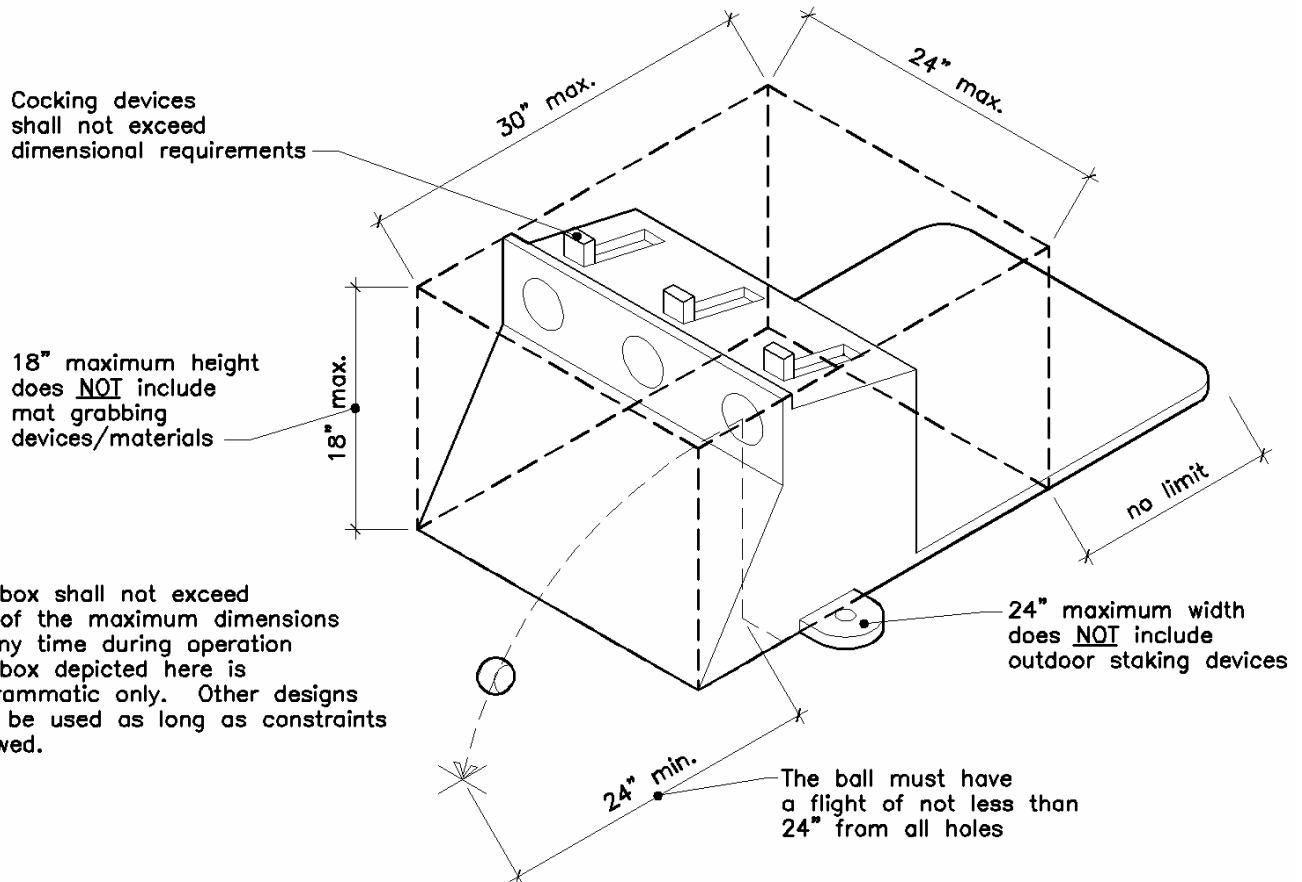

NOTES:

1. The box shall not exceed any of the maximum dimensions at any time during operation
2. The box depicted here is diagrammatic only. Other designs may be used as long as constraints followed.

Section 1.2 - Balls

Each club shall have a supply of round balls subject to the size, safety, and comfort of the dogs. Approved balls, to be retrieved from the box, may be any color, must bounce when dropped onto a hard surface, must roll, and must perform as required per Chapter 1 Section 1.1(d). Balls may not contain a noise maker, e.g. bells or squeakers.

Section 1.3 - Collars

Competitors are forbidden to use electronic, electronic dummy collars, and pinch/prong collars on the tournament grounds. The tournament grounds include racing lanes, spectator areas, and the crating area. Halters, including "haltees", will not be allowed in the racing ring. Flat collars, slip collars and harnesses are the only accepted type of collar. It is noted that it is impossible to control spectators with prong collars or other unapproved devices on their dogs who are not part of the tournament.

CHAPTER 2 - RING SET-UP

Section 2.1 - Footing

The host club shall provide adequate non-slip footing on the racing lane, at the box, and at the start.

Section 2.2 - Barriers

The host club shall provide a barrier/backstop at the box end of the run, placed as to prevent missed balls from rolling too far but placed as not to prevent proper observation by the judge or to obscure the spectators' view. A barrier (minimum 24" high) shall extend between the boxes, up to 2 feet in front of the box placement line, and a minimum of 5 feet behind the box placement line to minimize interference.

Section 2.3 - Jumps

(a) The host club shall provide two sets of regulation Flyball jumps for the duration of the tournament.

- (i) The jumps shall be white except for the uprights, which may be any color. The jumps shall have an inside width of 24 inches, with uprights not more than 36 inches high nor less than 24 inches high. Logos and/or lettering on the cross-boards will be permitted but must be located between 2 inches and 6 inches high and 2 inches inside of each upright.
- (ii) NAFA[®] requires all 1" and 2" jump boards be no thicker than 1/2" plywood, sintra, or similar approved material.
- (iii) NAFA[®] requires that a 1" board be the topmost board for all jump heights.
- (iv) Jump slats made of any material that are broken or bent must be removed from competition.
- (v) Jumps shall be within 1/4" in tolerance for height.

(b) There shall be a distance of six feet from the start/finish line to the first jump; ten (10) feet between each jump (four total), and 15 feet from the last jump to the box placement line.

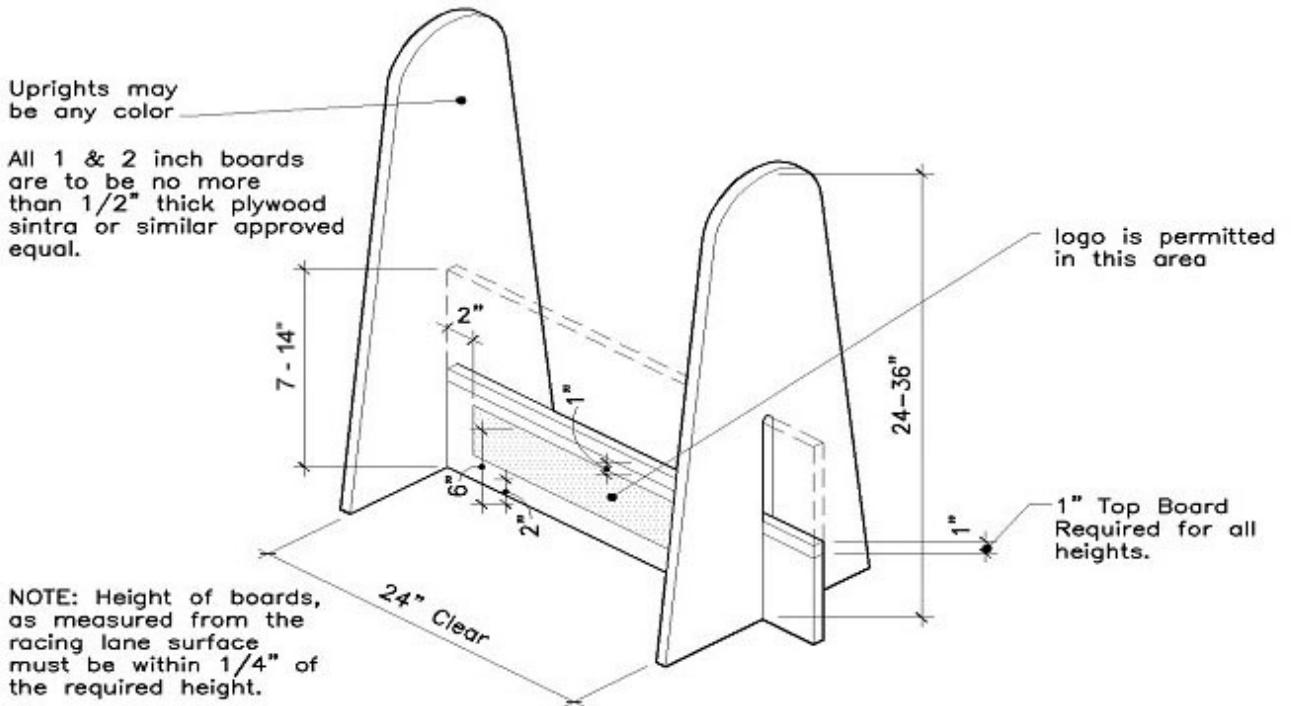

Section 2.4 - Ring Layout

(a) The minimum area required for two regulation lanes is approximately 30 feet by 110 feet. There shall be two racing lanes set a minimum of 12 feet from center to center and a maximum of 17 feet center to center. In cases of racing lanes being placed on hard surfaces or carpet (such as indoor/outdoor carpet where rug burns are possible), each racing lane shall be matted at a minimum 4.5 feet on either side of the racing lane center line for the length of the racing lane leading up to the first jump and an area from the last jump to the backstops. Where sod, dirt, grass or similar surfaces are available, matting shall not be required. All racing surfaces must be free of apparent contaminants. The length of the racing lane shall include an area not less than 50 feet leading up to the start/finish line and an area behind the box line and in front of the backstops to a minimum of 5 feet and that the backstops may protrude up to 2 feet in front of the box line. For tournaments held in venues that will not accommodate 50 feet of runback, the tournament director may apply for an exception from the Executive Director if adequate notice is given to teams and appropriate safety measures are put in place. If the Executive Director grants an exception, the tournament will not count for regional points.

(b) No equipment or other items may be between the racing lanes from the backstop to the start/finish line except those needed for utilizing the electronic judging system.

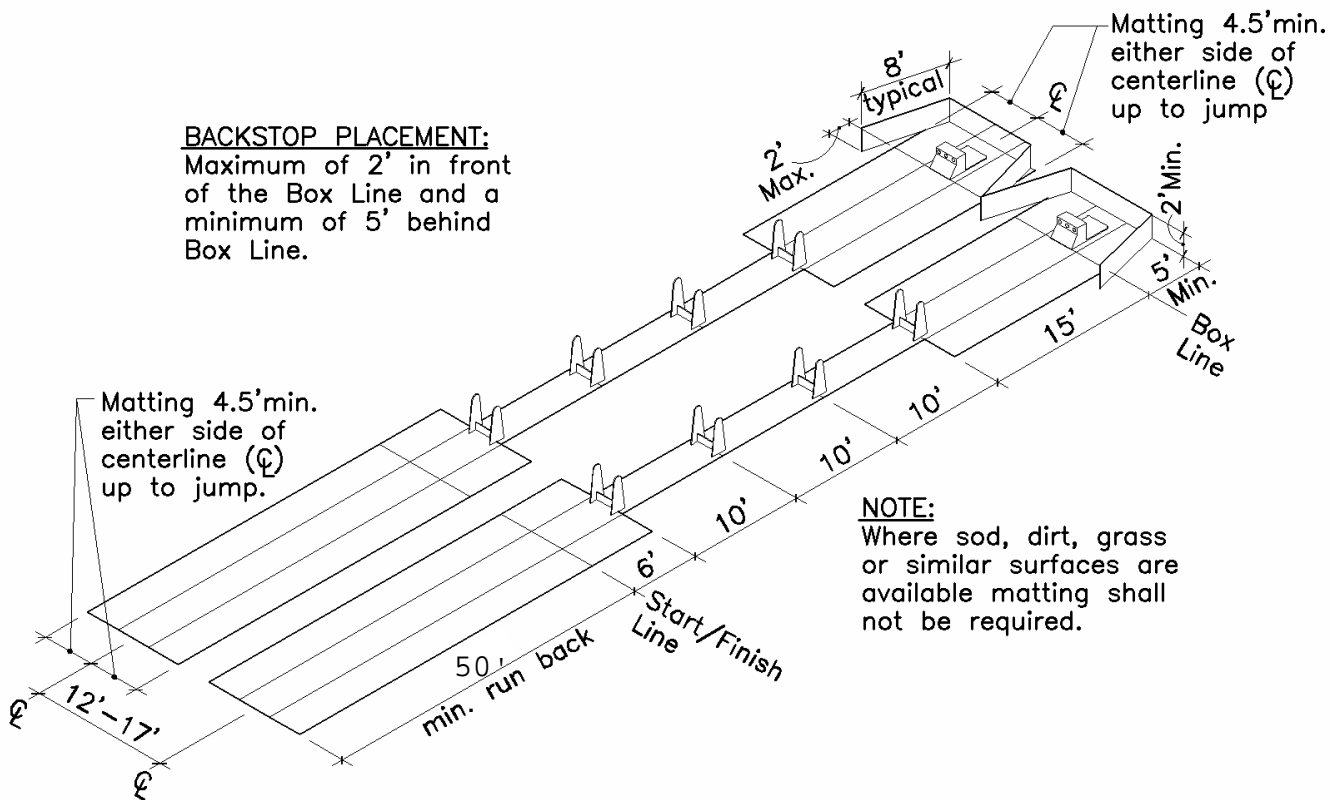

CHAPTER 3 - TEAMS AND TIMESHEETS

(a) A Competition Registration Number (CRN) must be obtained from NAFA[®] (use NAFA[®] Form C.8) prior to competing in a NAFA[®] sanctioned tournament. This number shall be used to identify the dog throughout its racing career. The fee for a CRN is \$20.00 in US currency or equivalent. The CRN is not transferable to another dog. The CRN shall indicate the breed of the dog. A dog's breed designation may be changed once in the lifetime of the dog.

(b) Any dog listed on a timesheet in a NAFA[®] sanctioned tournament without a valid CRN will result in forfeiture of tournament placement for the team as well as forfeiture of all NAFA[®] points earned during the tournament for all dogs entered on the timesheet.

(c) Each team is to consist of a minimum of four dogs and four handlers, with a maximum of six dogs and six handlers, plus a box loader and at the discretion of the team, a runner or two, to pick up loose tennis balls, to set up knocked down jumps, or to otherwise assist the team, provided doing so does not interfere with the judges or the opposing team and does not in any way assist the dogs in navigating the course or violate the rules.

(d) Each team is to have four dogs running in each heat, with a maximum of two alternates as standbys. The alternate(s) may be used at the team's discretion. Substitutions may only be

made at the end of each heat. Each dog on the team including the alternates must be declared prior to the 1st race of the division. Once the division has begun, there will be no substituting of the dogs entered on the team.

(e) A dog may be listed on two timesheets per day unless:

(i) All entries received for a tournament's limited entry Regular Class were not accepted at the conclusion of the automated draw.

(ii) The timesheets are in the same class of competition.

(iii) The dog is listed on a timesheet in Veterans Class. A dog listed on a time sheet in the Veteran's class at a tournament may not be listed on a time sheet for any other class of competition in that tournament unless the classes are scheduled so as to be run on separate days to a maximum of one additional class.

(f) The current time sheet (NAFA[®] Form C.2) shall be used.

(g) A Club must have a NAFA[®] Club Number to enter a NAFA[®] sanctioned event. If a Club Number has not been obtained prior to the closing date of the tournament in which the Club has entered, the teams entered by the Club will forfeit all NAFA[®] Points and tournament placements.

(h) Failure to record a jump height for a dog on the C.2 timesheet alone does not trigger the penalty specified in Section 7.6 and does not require forfeiting of the heats.

CHAPTER 4 - MEASURING

(a) At the discretion of the team, dogs jumping less than 14 inches may be measured by the measuring Judge officiating at the tournament during times designated by the host club. A dog must be entered in the tournament in order to have its height recorded on either the tournament Jump Heights (Form C.9) or a Height Card Application (Form C.10).

(b) The measurement area will be determined by the measuring Judge. The Judge shall select an appropriate measuring surface. Prior to measuring the first dog, and any time it is moved, the measuring device shall be calibrated to ensure accuracy. If the Judge determines that an appropriate measuring surface or that a NAFA[®] approved measuring device is not available, measuring shall be for the tournament only and not for an NAFA[®] Height Card Application (Form C-10).

(c) Measurements are to be open to public observation.

(d) Only one (1) handler per dog shall be allowed in the measuring area.

(e) The dog's height shall be measured from the ground to the top of withers with the dog standing in an upright position as indicated by Illustration 4.I. The handler may steady the dog if necessary, but shall not physically support the dog during the measuring process. The front legs will be vertical with the paws directly below the shoulders. The back legs will be positioned with the hocks perpendicular to the ground and spread no wider than the width of

the dog. The dog's entire head is to be in an upright position above the level of the withers as shown in Illustration 4.1.

Illustration 4.1 - Dog standing properly to be measured.

NAFA Flyball Measuring Stance

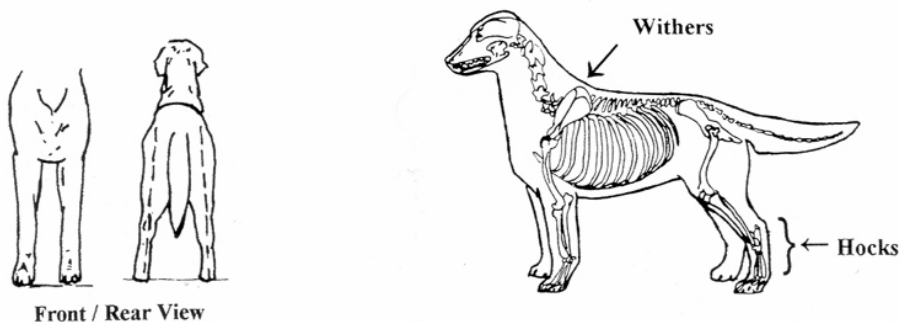
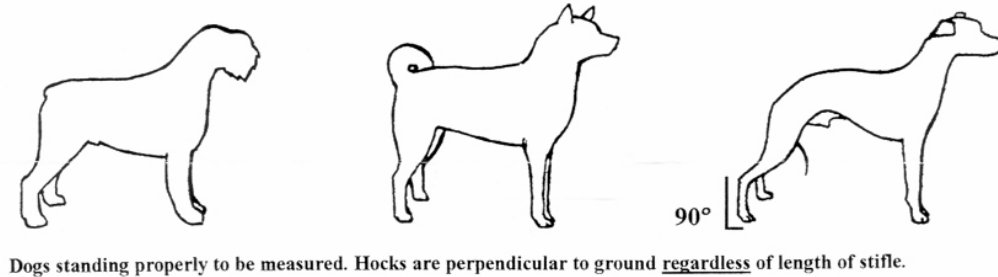

(f) The dog may be measured up to 3 times. The dog must be presented in an acceptable stand (as described in paragraph e and in illustration 4.1 above), within a reasonable period of time, not to exceed five minutes per attempt. The lowest measurement obtained by the judge shall be the dog's recorded height for that tournament.

(g) Aggression during measurement will not be tolerated and **Rule 8.4** (Aggressive Dogs) will be observed.

(h) A dog deemed to be "NOT MEASURABLE" by the measuring Judge will jump 14" hurdles.

(i) Height measurements are to be recorded by the Regional Director or designee and signed by the measuring Judge. A copy of the NAFA[®] Jump Height Form (Form C.9) must be posted for view by the tournament participants.

(j) In cases where multiple judges are measuring, once a dog's height has been measured and recorded by either judge on the Jump Height Form, it shall be the dog's official jump height for that tournament, regardless of which ring the dog may run in.

(k) Once the dog is measured, the judge is under no obligation to re-measure the same dog. If a dog is re-measured and the measuring Judge determines he has made a mistake, the team shall in no way be penalized. However, the team will be required to jump the proper height for any remaining heats.

(l) Any protest with respect to a dog's jump height must be verbalized to the Tournament Director and/or the Regional Director within 30 minutes of the heat in question by the Captain of a competing team in that division or combined division. The head judge may at any time measure a dog. At the time a dog is measured pursuant to a protest, all racing should stop until measuring has concluded. In the event a team has failed to record the dog's jump height on the C.2 timesheet and the dog fails the jump height challenge, it will be presumed that the team was jumping the incorrect height in all preceding heats where the dog was circled.

(m) After a protest or a measuring performed at the head judge's request, if the head judge determines a team is not jumping at least the minimum height in a round robin format, the team shall forfeit any heats run at the improper jump height. In the case of an elimination format, the team shall be excused.

(n) Height Cards are to be optional. Refer to NAFA[®] Corporate Policies & Procedures, Chapter 7, Section 7.1 for details on height cards.

CHAPTER 5 - JUDGES

(a) Five judges shall officiate when two teams are running.

(b) One judge shall be positioned at each team's starting line, facing each other; one judge is to be located at the box end in each lane, with a good view of the box loader, but not positioned so as to interfere with or distract the dog; and a fifth judge, the Head Judge, shall act as starter and referee.

(c) The Box Judges and Line Judges shall remain stationary during each heat; dogs may go around judges and balls bouncing off of a judge shall be deemed in play. The principal responsibility of each Box Judge and each Line Judge is to watch for violations in the racing lane that they are assigned.

(d) The Head Judge (starter and referee) shall be positioned between the racing lanes in the area between the start/finish line and the lead dogs to start the heat. If necessary, a Head Judge shall reposition himself/herself so as not to interfere with competing teams. The Head Judge may confer with the Line Judges and the Box Judges before determining a winner.

(e) Judges shall indicate with a signal, which dogs must rerun. It's the handler's responsibility to note the signal and rerun their dog. If it is necessary to stop a heat, the judge shall use a whistle.

(f) The Head Judge shall stop the heat for interference, fouling in the racing ring, or undue aggression by dog or competitor and award that heat to the competing team.

(g) Line judges shall

(i) record which dogs participate in every heat and record win/loss using the NAFA[®] Time Sheet(NAFA[®] Form C.2);

(ii) indicate with a signal when an infraction has occurred.

CHAPTER 6 - REPORTING FOR RACES

(a) If a team is more than three minutes late from the conclusion of the designated warm-up period, the Head Judge will declare a forfeit of that race by that team unless an excused ring conflict exists. Any ring conflicts must be reported to the Head Judge or the Head Table prior to the race in question.

(b) Teams that win by forfeit must complete the minimum required heats scheduled to qualify for points awarded in round-robin or to advance in double elimination competition. If another team is not available to compete, the team shall race without an opponent.

(c) Forfeiting teams that do not show just cause may be excused from the tournament by the tournament director and may be subject to further discipline. Forfeiting teams may not run any dogs in the heats that are forfeited. If a team forfeits a heat and then subsequently runs a dog(s) in violation of this rule, they will automatically be considered as For Exhibition Only (FEO).

(d) If a team has to forfeit when its "A" and "B" teams are in the same race, the faster seeded team must run and the slower seeded team must forfeit.

(e) Once a team declares itself For Exhibition Only, the team cannot return to regular competition. From that point on, the team can no longer obtain NAFA[®] points or tournament points. FEO teams may not run if the opposing team raises an objection with the judge. Once teams declare themselves For Exhibition Only, they are ineligible for placement and shall be placed in the lowest seed of any eliminations. A club cannot enter a team into a NAFA[®] sanctioned event For Exhibition Only. A team running For Exhibition Only is subject to all the rules of competition with the exception of the following:

- (i) 3 or 4 dogs may be run in a heat;
- (ii) false starts are not in effect;
- (iii) any jump height from 7" to 14" is allowed at the discretion of the team;
- (iv) less than four breeds may be run in multi-breed classes;
- (v) in the event a dog receives a flag, it may complete its run but not rerun; and
- (vi) the judge may excuse the team from the race for failure to comply with these conditions or other NAFA[®] rules.

CHAPTER 7 - WARM-UPS

(a) There shall be a designated time period for warm-ups.

(b) There shall be no practice or training in the ring for the duration of the racing day, except for the warm-up as permitted prior to each race. Training in the ring during the competition will mean a forfeit of the heat.

(c) When a team is delayed by an excused ring conflict, warm-ups shall not begin until both teams are present in the ring unless warm-ups have been waived. Teams already present and waiting may set their jumps and place their box.

(d) Only dogs listed on the team's timesheet are allowed to warm up. Each dog must have a valid CRN and be eligible to compete. Any dog(s) that warm up in violation of this rule will cause the forfeiture of all NAFA[®] points earned during the tournament for all dogs on the timesheet. The team with the dog that violated this rule will also forfeit any tournament placement.

CHAPTER 8 - RULES OF RACING

Section 8.1 - Tournament Seeding/Breakout Rule

Tournaments will be seeded by the times submitted with the team's entry. After the closing date, the tournament director will divide the entered teams into divisions. Each division's breakout time will be one (1) second faster than the top team's seed time. Except in Division 1, a team running more than one (1) second faster than the top team's seed time will "breakout" of the division and will be declared the loser of the heat. **NOTE:** Tournament time sheets should be marked BO and show a loss, however the actual time run should still be recorded for NAFA dog points.

- (i) A team that breaks out three (3) times in a tournament is ineligible for any tournament placement; NAFA[®] points are still awarded for completed heats;
- (ii) In the event both teams in a heat breakout, both teams will be awarded a loss;
- (iii) When one team breaks out and the other team does not finish its heat, both teams will be awarded a loss;
- (iv) When the timing table misses calling breakouts and the race has ended, the breakout wins are to be converted to losses. If the converted losses leave the race undecided, additional heats will be run to complete the race;
- (v) In elimination rounds, where seeding is determined by Round Robin, a team ineligible for placement shall be seeded last;
- (vi) In elimination round heats, where a team ineligible for placement competes against a team eligible for placement, the ineligible team shall be awarded a loss.

Section 8.2 - Jump Heights

(a) Except as provided in paragraph 8.2(c) below, jump heights shall be set at a minimum of five inches lower than the height at the withers of the smallest dog on the team (running, not stand-by), to a minimum of 7 inches. Maximum jump height shall be 14 inches;

(b) Jump heights shall be adjusted in one inch increments, to the lowest whole number (13 and 3/4 inches becomes 13 inches).

(c) In the Veteran's Class, jump heights shall be set at the minimum height stated in paragraph 8.2(a) without regard to the height of the dogs racing.

Section 8.3 - The Heat

(a) The Run. Dogs may start from a stationary or running start. Each dog is to hurdle the four jumps in succession, trigger the box, releasing the ball, retrieve the ball and return over all

four jumps and the start/finish line with the ball in its mouth. Only when the first dog has reached the start/finish line with any part of its body (on the ground or in the air) may the second dog reach the start/finish line with any part of its body (generally this is a nose to nose pass at the start/finish line), and so on for all four dogs as well as dogs that must run again.

(b) False starts. Except in the Veteran's Class:

(i) When any part of the dog's body, whether in the air or on the ground, or any part of the handler's body or their objects passes the start/finish line before the timing of the race begins, an infraction will be called by the line judge and the head judge and the heat will be rerun;

(ii) If a second such infraction is called against the same team for that heat, an infraction will be indicated and the dog must run again;

(iii) If a second false start is called coincident with the opposing team's first false start, the heat is to be rerun.

In the Veteran's class, and in heats with direct competition between an open and a veteran team pursuant to Rule 6.2(e)(iii), heats will not be restarted for false starts but shall continue, with the dog that committed the false start being required to rerun for the team to complete the heat.

(c) Box Malfunction. The box loader shall indicate to the Head Judge when there is a box malfunction. The heat shall be stopped. The Head Judge is to examine the box. If, in the opinion of the Head Judge, the box has malfunctioned the heat shall be run again. If the box is found to be working, then the heat shall be forfeited. If another box is not available and the box cannot be repaired in a reasonable time, the heat and any remaining heats are to be forfeited. If the box malfunctions a second time (or the spare box malfunctions) in the same race, the heat shall be forfeited and all remaining heats in that race shall be forfeited.

(d) Fouling. If a dog urinates or defecates in the racing ring during a heat, the judge will stop that heat and award that heat to the opposing team assigning them an estimated time. If a dog urinates or defecates in the racing ring at any time prior to the first heat or between heats, the judge will award the next heat to the opposing team, assigning an estimated time to that team. The time will be marked as estimated and will not be used to determine placement.

(e) Conduct of the box loader. Except during the warm up, to retrieve a loose ball, or to get a fresh supply of balls to load for the current heat, the box loader must remain in the upright position behind the box, and may offer verbal encouragement only, as long as such encouragement does not distract the opposing team. For deaf dogs, box loaders should be permitted to use a subtle hand signal as long as it does not interfere with other competitors. As a courtesy to opposing teams, the box loader is to remain in position until the outcome of the heat is determined by the Head Judge. If, in the judge's opinion, a box loader has violated any of these rules, their team may forfeit the heat.

(f) Inside Interference. If a dog or any team member interferes with the opposing team during a heat, the team causing the interference will forfeit the heat. This includes interference in the racing lane, in all in bound areas, and in the area where dogs are waiting to run. Interference

is defined as impeding the other team's dog from running its race. A dog chasing a loose ball into the other team's area is not necessarily interference. In the event of interference, the judge will assign an estimated time to the team that was interfered with. The time will be marked as estimated and will not be used to determine placement.

(g) Distractions. Team members shall not distract the opposing team by any means, nor throw any object for their dogs (i.e. balls, toys, Frisbees, dummies, gloves, or treats). Team members are required to pick up any loose balls. The first offense of these infractions shall receive a warning; a second offense and any offense thereafter during the race will result in the loss of the heat.

(h) Safety Hazards/Outside Interference. If, in the opinion of the head judge, a safety hazard exists during the running of the heat, the heat shall be stopped and restarted. Lineups may be changed without penalty.

(i) Flags. Dogs that receive a flag must be rerun after the initial four dogs in the order they were flagged. Racing infractions requiring the rerunning of a dog include:

(i) Early passes will be indicated by the EJS and the Line Judge and/or the head judge. When running without an EJS system, the line judge will indicate an infraction;

(ii) Missed jumps;

(iii) Not carrying the ball over each jump in succession;

(iv) Does not trigger the box;

(v) Dog takes the ball from the cup without first triggering the box;

(vi) Does not carry the ball over the start/finish line;

(vii) Inappropriately assisted by the boxloader, spectator or handler;

(viii) A handler or their object crosses the start/finish line during the dog's run (with the exception of resetting knocked down jump(s) or retrieving loose ball(s)).

(j) Knocked down jumps. A team whose dog(s) knocks down a jump(s) during its run shall not be penalized, provided all dog(s) clear the jump(s) as if it were standing. A "runner" or handler may set up knocked down jump(s) if so doing does not interfere with either team or guide the dog in any way. Even if the judge does not stop the heat for a knocked down jump(s), it is up to the individual competitor to decide whether it is appropriate to run his or her dog, or to accept a no finish.

(k) Intervention. Should the ball bounce back in the cup as the dog tries to catch it, the box loader may re-set the box for the dog to trigger it (without penalty). For deaf dogs, box loaders should be permitted to use a subtle hand signal as long as it does not interfere with other competitors. These are the only times at which the box loader is permitted to signal a dog to push the pedal.

(l) The finish. The first team to have all four dogs successfully complete a run wins the heat. The finish shall be when the last of the four dogs reaches the finish line with any part of its body.

(m) Winner. Determining the winner of a heat:

(i) When a heat is judged using the Electronic Judging System, the winner of close heats shall be determined based on the Electronic Judging System times.

(ii) Video shall not be used to override, or help determine the winner of a heat. Video can be used to remove a malfunctioning EJS from the ring, but it may not be used by a judge as the basis to rerun a heat.

Section 8.4 - Aggressive Dogs

If a dog shows undue aggression at any time during the competition, the Head Judge may excuse the dog from competing. The Head Judge must report any dog excused from competition on NAFA[®] Form C.12. The Head Judge is responsible for sending the completed form to the NAFA[®] corporate address within ten days of the incident. Ordinarily, the Regional Director and dog owner/handler (and/or club owner) should receive a copy of the incident report at the tournament. In the event that this becomes impracticable, copies shall be distributed to those individuals within ten days of the incident.

Section 8.5 - Condition of Dogs

(a) To compete, a dog must be safely able to complete the course.

(b) A handicapped dog may compete if the Head Judge determines that the dog meets the criteria in 8.5(a).

(c) The Head Judge has the right to inspect any dog at any time during the tournament. If in the opinion of the Head Judge a dog is lame, in season, recovering from surgery or cannot safely compete, the dog shall be excused from competition. The Head Judge must report any dog excused from competition to the Executive Director on NAFA[®] Form C.12.

(d) Protective wrap on a dog's legs may be used.

Section 8.6 - Race Results

Host clubs must post race results (heat times and wins/losses) for competitors, as soon as possible, following the running of each race.

Section 8.7 - Racing without the Electronic Judging System (EJS)

The following rules apply when racing any heat without an EJS for any reason:

(a) The breakout rule (section 8.1) does not apply;

(b) Racing procedures:

(i) The Head Judge (starter and referee) shall be positioned between the racing lanes in the area between the start/finish line and the lead dogs to start the heat. If necessary, a Head Judge shall reposition himself/herself so as not to interfere with competing teams.

(ii) The Head Judge shall maintain a consistent starting cadence of approximately one (1) second intervals throughout the tournament, and shall indicate the start with a whistle.

Timing of the heat begins with the whistle. For example, please see illustration 5.1. In tournaments with multiple judges, uniform visual start signals should be used.

Illustration 5.1 – Starting positions without Electronic Judging System

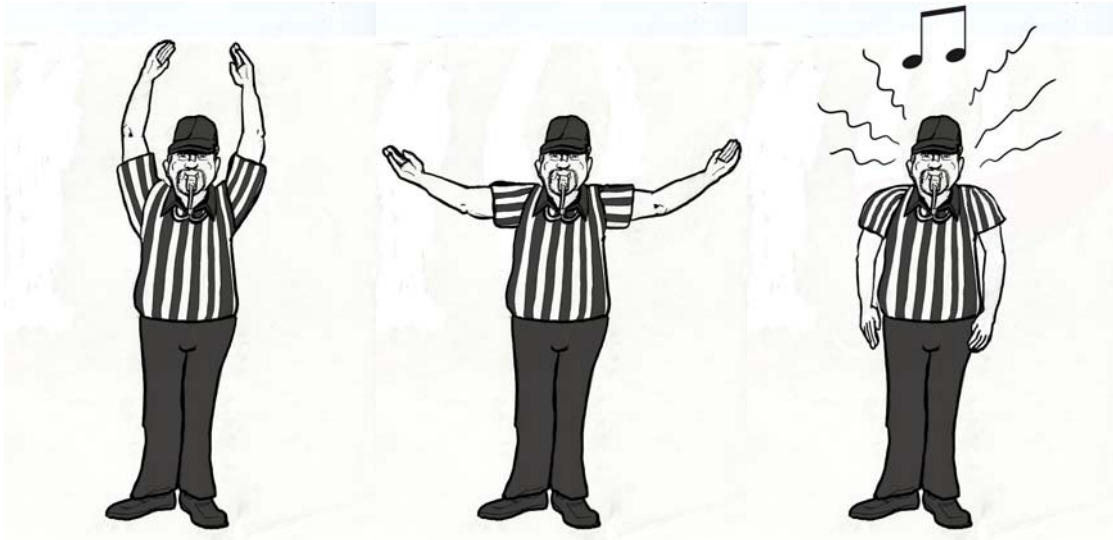

“Ready” “Set” “Tweeet”

(c) Early passes and other infractions will be indicated by the Line Judge and/or the Head Judge;

(d) If necessary, the Head Judge (starter and referee) should be in position to assist the Line Judges in determining winners of close heats.

(e) In determining the winner of the heat, the Line Judges’ decision must be unanimous and shall be based on their visual view of the finish line, **not on the clocks**. If the Line Judges are not in agreement, the Head Judge shall consult with the Line Judges and either declare a winner or declare the heat to be a tie.

GLOSSARY

Breakout - when a team, during competition, runs faster than the designated time for the division in which it is competing. See Chapter 8, Section 8.1.

Class - An established category of racing. See Chapter 5, section 5.2 of Corporate Policies & Procedures.

Club - an organization that is registered with NAFA[®] and is represented solely by one Owner.

Excused Ring Conflict - A ring conflict that is reported to and accepted by the Head Judge or Head Table prior to the start of the race.

For Exhibition Only (FEO) - where a team chooses not compete in a tournament. See Chapter 6 (e).

Forfeit - Where a team cannot, or chooses not to complete, and thus loses the race. See Chapter 6 (b) & (c).

Good Standing - A Club is not in good standing with NAFA[®] when any of the following are true: (i) the Club is not current paying NAFA[®] fees; (ii) the Club itself is on probation or suspension; (iii) the owner of the Club is on probation or suspension. A person is not in good standing with NAFA[®] when any of the following are true: (i) the person is not current paying NAFA[®] fees; (ii) the person is on probation or suspension.

Handler - The person releasing and/or catching the dog.

Heat - a single competition in which a winner or tie is determined, several of which will determine the winner of the race.

Inside Interference - Where a factor inside the racing lane interferes with a team during a heat.

Not Measureable - Refuses to stand; refuses to stand still; refuses to stand in an appropriate measuring stance as set forth in Chapter 4 (e) and illustration 4.1, Rules of Racing, which results in the measuring judge being unable to take an accurate measurement. At any time before a final measurement is taken and committed to paper, a handler may walk away and the dog will be treated as if it had not been presented for measuring.

Outside Interference – Where a factor from outside the racing lane, not involved in the current heat, interferes with a team during a heat.

Racing year - The NAFA[®] Racing year runs from October 1 through September 30 of the following year and is the NAFA[®] fiscal year. See NAFA[®] Bylaws Article VIII Section 2.

Race - a group of heats that determine a victor.

Racing day – the racing day begins thirty minutes before the first scheduled race and ends after the conclusion of the last race of the day and the Electronic Judging System has been removed (unless the Executive Director has granted permission for use of the EJS outside of racing)..

Racing lane – The racing lane extends from the backstop behind the box, through the course, through the start finish line, to the point where the racing surface (grass, matting, etc.) no longer extends at least 4.5 feet on either side of the racing lane center line. See also the diagram in Section 2.4 – Ring Layout.

Ring - the area in which flyball racing occurs. This area includes the racing lanes, from the backstops to the start/finish lines, the runback area and the required clearances beside the racing lanes/runback area. See Chapter 2.

Runback – That area of the racing lane leading up to the start finish line, before the course, which consists of the racing surface (grass, matting, etc.) a minimum of 4.5 feet on either side of the racing lane center line. This distance is required on the sanctioning form to sanction an event.

Start/finish line - a line on the floor which determines the plane which the dog crosses to start and end his run. See Chapter 2 - Ring Setup and Chapter 8, Section 8.3 -The Run.

Team - a subpart of a club. Teams are created by the Club to compete at NAFA[®] Sanctioned Events.

Tournament - an event where clubs and teams compete, using agreed upon rules, format, and regulations.

Tournament week - A tournament week runs from Wednesday through Tuesday of the following week.

Training in the ring - where, once racing has started and before the end of the racing day, the handler uses techniques and/or devices that would be used to train. See Chapter 7 warm-ups, Chapter 8, Section 8.3 - The Run.

NORTH AMERICAN FLYBALL ASSOCIATION, INC.®

CORPORATE POLICIES & PROCEDURES

CHAPTER 1 – EXECUTIVE DIRECTOR STAFF

Section 1.1 – Statistician

The Executive Director will appoint one or more statisticians to manage the following:

- (i) Maintain records and manage changes and additions.
- (ii) Process applications for new clubs and assign club numbers.
- (iii) Issue Competition Racing Numbers (CRNs).
- (iv) Mail certificates and point summaries to clubs on a quarterly basis.
- (v) Score tournament timesheets and submit results to the NAFA[®] database.
- (vi) Distribute pins for awards earned.
- (vii) Distribute plaques for awards earned.

Section 1.2 – Tournament Sanctioning Secretary

The Tournament Sanctioning Secretary is appointed by the Executive Director and is responsible for:

- (i) The sanctioning of NAFA[®] tournaments.
- (ii) Confirmation of sanctioning,
- (iii) Confirmation of receipt of certificate of additional insured.

Section 1.3 – Webpage

The NAFA[®] webpage (www.flyball.org) is the primary means of disseminating the latest information to the NAFA[®] flyball community.

Section 1.4 – EJS Coordinator

The Executive Director shall appoint one or more EJS coordinators to be responsible for:

- (i) The coordination and shipping of NAFA[®] owned EJS systems to tournaments in their specified geography.
- (ii) The collection of requirements for future EJS systems or changes to current EJS systems.
- (iii) The maintenance of EJS systems to assure continued, reliable operation.

Section 1.5 – Webmaster

The Executive Director shall appoint one or more webmasters, responsible for the following:

- (i) Procurement of web servers to host NAFA[®] content on the World-wide web.
- (ii) Maintenance of content to be presented on the web, including the assurance of its currency.
- (iii) Recommending new and innovative ways NAFA[®] might exploit emerging web technology to further its stated purposes.

Section 1.6 – Regional Directors

(a) NAFA[®]'s geography shall be divided into regions by the Executive Director and approved by the Board of Directors.

(b) Regional Directors shall be appointed by the Executive Director, and approved by the Board of Directors. Upon a change of Executive Director, the slate of Regional Directors shall be tendered for approval at the next in-person meeting of the Board of Directors.

(c) The Regional Director will be responsible for a geographical region based on the number of clubs and tournaments.

(d) The Regional Director shall:

(i) be willing and capable of advising and assisting new clubs;

(ii) work with the tournament directors and be responsible for the final approval of the tournament schedule, format and the seeding of teams at NAFA[®] sanctioned tournaments;

(iii) communicate regional business with the Executive Director;

(iv) attend or be represented at NAFA[®] sanctioned tournaments in their region;

(v) have the authority to put on notice the tournament director, host club, competing club, individuals, or judge for violating NAFA[®] Rules or policies or for engaging in conduct prejudicial to the sport;

(vi) have the authority to excuse any individual from a tournament for breach of Code of Ethics;

(vii) observe the measuring of dogs by Head Judges, using NAFA[®] supplied and approved measuring devices;

(viii) demonstrate a knowledge of the NAFA[®] Rules of Racing and Corporate Policies & Procedures, and be in good standing with NAFA[®].

(e) If the Regional Director is the tournament director or is actively measuring or judging during the tournament, the Regional Director shall designate an acting Regional Director while those duties are fulfilled. Such designation shall be approved by the Executive Director.

(f) The Regional Director shall comply with the NAFA[®] Conflict of Interest Policy stated in Chapter 9.

CHAPTER 2 – JUDGES

(a) Judges must be in good standing with NAFA[®]. Judges should be friendly and courteous, even sympathetic, but above all impartial and firm. Judges must have a thorough understanding of the rules and policies gained through personal experience.

(b) The judge's responsibility also extends to the exhibitors, to the host club or organization, and the spectators and sponsors. A judge must be an arbiter and diplomat. A judge must

leave exhibitors and spectators with the feeling that each team was given an equal opportunity and no team was given an unfair advantage.

(c) A judge is not to engage in conversation with a disgruntled exhibitor. The Head Judge may excuse any person for breach of the Code of Ethics.

(d) Upon arriving at the site, a judge shall immediately report to the tournament director. Judges should be at their ring at least one half hour before the competition to check the ring, jumps, matting, and backstops. If dogs are to be measured and boxes inspected before the competition, the judge should allow additional time as directed by the tournament director.

(e) The Rules of Racing and Corporate Policies & Procedures are a basic guide. They should not be considered a manual containing explicit direction for every possible situation. Judgment calls should be based on the experience, good character, and fairness of the judge. The intelligent application of discretionary authority demands that a judge exercise common sense, fairness, and initiative. **Above all else, the safety and well being of the dogs and exhibitors shall be foremost.**

(f) A judge is allowed to make a reasonable accommodation and/or exceptions to the Rules of Racing for the needs of a handicapped dog and/or handler so long as these accommodations do not interfere with other competitors. For deaf dogs, box loaders should be permitted to use a subtle hand signal as long as it does not interfere with other competitors.

(g) Judges shall not assist teams during warm-ups.

(h) Persons interested in becoming an approved NAFA[®] judge must follow the procedure outlined in Appendix D – Judges Training Program.

(i) In each racing year, a Head Judge must judge at least one division in three tournaments on different weekends. The judge must be the Measuring Head Judge on one of those three weekends. Judges who do not fulfill the requirements to maintain their active status in any one year must judge at least two divisions of a sanctioned tournament on different weekends under the supervision of a NAFA[®] Supervising Head Judge and then judge two additional tournaments. Two of the four assignments must include measuring of dogs with one being under the supervision of a NAFA[®] Supervising Head Judge. The judge, when seeking reinstatement, must obtain a completed C18 form for each of the four assignments and submit them to the judge's committee for approval. A judge, who's approved status lapses for more than one year, will not be reinstated as the judge must begin the Novice process again.

(j) The following is a list of criteria for NAFA[®] Supervisory Head Judge status:

(i) Prospective judges must have been involved in the sport of flyball for a minimum of 5 years, with at least 3 continuous years as a NAFA[®] approved judge.

(ii) Prospective judges must be in good standing with NAFA[®], with no letters of discipline, probation or suspension in their records, dating back at least 5 years.

(iii) In the time the prospective judge has been judging, he or she must have judged a minimum of one division in 25 tournaments on separate weekends, in order to gain the kind of experience required to supervise new judges

(iv) Prospective judges must possess all of the best qualities one could want in a Supervising Judge....fairness, firmness, safety minded, a good attitude to the sport, the participants, the spectators, a sense of responsibility to the sport and as a representative of NAFA®.

(v) Prospective judges must be willing and able to mentor new and apprentice judges, answering questions, challenging apprentices, and generally overseeing the education of the new judge. The sharing of experiences and the ability to explain rulings and other nuances of the sport are an absolute must.

(vi) Prospective judges must have excellent measuring skills since his or her measurement is the deciding factor for any height cards.

(vii) Prospective judges for Supervisory status may be proposed to the Board of Directors in writing by any Board member, judge, or participant in official NAFA® events. Such proposals must be accompanied by a letter of recommendation from at least 5 different tournament directors the applicant has judged for, two fellow NAFA approved judges, and the Regional Director for the applicant's home region. Said letters of recommendation should contain personal observations of any of the qualities referenced in (iv) above. In addition, the name of the judge applying for supervising status will be published on the NAFA webpage for a period, ideally of seven days, to allow for comment to the Board.

(viii) Prior to the application being presented to the Board, the applicant will be required to meet with the Judges Committee via telephone conference to discuss his or her application.

(ix) It is understood that the meeting of all of the necessary criteria for Supervisory status does not mean an automatic approval by the Board of Directors. It is not the intention of the Board to appoint great numbers of Supervisory Judges in any area.

(x) The Board of Directors reserves the right to revoke Supervisory status at any time for just cause.

(xi) If a Supervising Judge fails to maintain his/her regular judging status, Supervising Judge status is revoked and must be reapplied for.

(k) Line or box judges under the age of 18 must have prior approval from the Regional Director. (Head Judges should also be notified).

(l) Judges are not permitted to consume alcohol during their judging assignment.

(m) The Board of Directors reserves the right to revoke a Judge's status at any time for just cause.

(n) When selecting judging attire, it is to be understood that the judge is in the ring to evaluate the team performance and not to be the center of attention. Judges are expected to uphold an image of integrity and professionalism at all times and an integral part of this image is appropriate attire. A judge shall not wear any apparel bearing prominent business, sponsor or other organization's insignia without the permission of NAFA®. Judge's jerseys shall be black, white or combinations of those colors. Head Judges shall not wear the uniforms or hats of any

racing clubs. It is highly encouraged, but not required, that relief judges comply with this standard while judging

CHAPTER 3 – ANNUAL GENERAL MEETING

(a) An annual meeting will be held each year to discuss old and new business and tabulate votes for Board members and the Executive Director as required.

(b) The actual number of votes for each candidate will be made public at the annual meeting and published.

CHAPTER 4 – DELEGATE VOTES

(a) When the Board of Directors calls for a delegate vote on a topic, the proposed issue will be published on the NAFA[®] web page for comment. Following a three (3) month comment period a vote will be called. For the motion to pass, the motion must be supported by 2/3 of the delegate ballots returned and validly voted. Delegate votes shall be conducted by mail or other similar means.

(b) All delegates shall be assigned to the club owner.

(c) Any items put to delegate vote and defeated cannot come up again for 3 years.

(d) Delegate voting may be conducted by paper ballot, electronic balloting, or a combination of both.

CHAPTER 5 – CODE OF CONDUCT

Section 5.1 – Code of Ethics

(a) One of the objectives of NAFA[®] is to promote cooperation and good sportsmanship in the training and exhibition of dogs. Cooperation and good sportsmanship should not be recognized in passive observance, but as a way of life in training and competition. Participants shall at all times be courteous and friendly and never conduct themselves in a manner that would bring discredit to Flyball. At no time should they show displeasure with a dog, judge, exhibitor, NAFA[®] representative, sponsor, host, or spectator in or out of the ring.

(b) Training and exhibiting shall be carried out by such methods that keep in the best interest of the dog and Flyball.

(c) Abuse or severe disciplining of a dog is not in the best interest of Flyball. No dog under the age of one (1) year may be listed on a timesheet in a sanctioned event.

(d) Misconduct shall include, but not be limited to, abusive or foul language, demonstration of dissatisfaction with a judge's decision, inhumane treatment of a dog, racing a dog who is not in adequate physical condition for the number of heats the dog is asked to run, demonstration of poor sportsmanship, willful violation of the rules with the intent to gain an unfair advantage,

or any other behavior or altercation that would leave a spectator or exhibitor with an unfavorable opinion of Flyball.

(e) Participants shall always follow the Rules of Racing and Corporate Policies & Procedures, showing knowledge and an understanding of the same.

(f) Any individual or club in good standing with NAFA[®] may file a protest or prefer charges against another individual or club for alleged misconduct, in or out of the ring, prejudicial to the best interest of flyball as provided for under Section 5.2. Protests filed during competition should be done in such a manner as not to bring discredit to flyball.

(g) Regional Directors should warn teams and file unsportsmanlike conduct charges if teams are obviously and repeatedly holding back their dogs in tournaments to gain an unfair advantage.

Section 5.2 – Discipline

(a) Charges - Anyone in good standing with NAFA[®] may prefer charges against another for conduct prejudicial to the best interest of Flyball. Written charges must be filed with the Board of Directors with a \$100.00 fee USD or CDN, which will be forfeited if the charges are not sustained.

(b) Hearing – The Board of Directors shall set a date, time, and place to consider the charges. Both the accused and the complainant shall be notified as to the date, time, and place of the hearing.

(c) Discipline - Should the charges be sustained, after hearing all the evidence presented, first by the complainant and second by the accused, by a majority vote, the Board of Directors may suspend or place on probation the defendant from all NAFA[®] benefits and privileges. Accused individuals who are also members of the Board of Directors may not vote in such cases of discipline.

Section 5.3 - Pre-hearing

(a) Preliminary Investigation: The NAFA[®] Board of Directors' Disciplinary Committee or their appointee(s) shall investigate all complaints and make a preliminary determination. The Disciplinary Committee shall determine whether, if proven true, the action was prejudicial to the sport and whether it occurred at or in connection with the NAFA[®] sanctioned event. This preliminary determination shall be brought before the Board of Directors by the Disciplinary Committee for review.

(b) Hearing Notice: If following the preliminary investigation it is determined that the alleged misconduct, if proven true, would be prejudicial to the sport and that it occurred at or in connection with a NAFA[®] sanctioned event, then the accused must be advised of:

- (i) the charges and specific conduct alleged to be prejudicial to Flyball;
- (ii) where and when the hearing will be held;
- (iii) when and where the alleged misconduct occurred;

- (iv) their rights to be present, to testify and to present witnesses and;
 - (v) if the accused prefers, they may present their defense in writing.
- (c) The accused must be given reasonable time to secure witnesses and prepare a defense.

Section 5.4 - Hearing

(a) For the purposes of this hearing the NAFA[®] Board of Directors shall be known as "the committee". The Chairperson of the NAFA[®] Board of Directors shall be the Chairperson of the hearing.

(b) The Chairperson introduces themselves and the members of the committee and designates one member to keep a record of the proceedings.

(c) The Chairperson advises the accused of the specific charges.

(d) The Chairperson advises the accused of the right to

- (i) hear, confront, and question all witnesses;
- (ii) to present witnesses on their behalf and;
- (iii) to testify on their behalf.

(e) The Chairperson shall determine and list witnesses to be called by the committee and the accused.

(f) The Chairperson excuses all persons except the committee, the accused, and the witnesses.

(g) The Chairperson shall call the witnesses, first those named by the committee and then those named by the accused. The Chairperson shall ascertain the full name and address of each witness as they are called. The Chairperson shall question the witness and then allow the accused to question the witness.

(h) After all witnesses have testified, the Chairperson shall permit the accused to make a final statement in response to the charges.

(i) The Chairperson shall then excuse all persons except the committee. The Chairperson shall ask the accused to remain available to receive the committee's decision.

Section 5.5 - Post-Hearing

(a) After deliberation and by majority vote, the committee shall determine;

- (i) whether the charged conduct has been proved;
- (ii) whether such conduct was prejudicial to the best interest of the sport of Flyball; and
- (iii) whether the charged conduct occurred in connection with or during the progress of a NAFA[®] sanctioned event.

(b) If any of Sections 5.5 (a), (i), (ii), or (iii) are not proven, the committee shall dismiss the charges. If Section 5.5 (a), (i), (ii), and (iii) are proven to be true, the committee may suspend the accused from all NAFA[®] membership or take other appropriate disciplinary action.

(c) After the committee makes its decision, the Chairperson shall;

(i) if possible, immediately notify the accused of the committee's decision and any discipline taken;

(ii) notify the accused, in writing, by registered or certified mail, of the committee's decision and any discipline taken, and;

(iii) prepare a complete report of the proceedings for the records and send a duplicate copy of the report to the accused.

Section 5.6 - Probation

(a) A Regional Director may put on notice a tournament director, club, individual, or judge within their region for violating NAFA[®] Rules of Racing and Corporate Policies & Procedures or for conduct prejudicial to Flyball. The notice, whether oral or written, must be documented and forwarded to the Executive Director. A second notice for the same or similar violations or for conduct prejudicial to Flyball shall be reported to the Executive Director who shall forward it to the Board of Directors for appropriate action.

(b) The Board of Directors may put a tournament director, club, individual, Regional Director or judge on probation for one year. If the problem is not corrected to the satisfaction of the Board of Directors, the tournament director, club, individual or judge may be prohibited from participating in NAFA[®] sanctioned events.

(c) A club that is not in good standing or is on probation will not be awarded regional points for any portion of a racing year at any tournament at which they compete. The points will be awarded to the next highest placing team in good standing.

Section 5.7 - Aggressive Dogs

If a dog shows undue aggression at any time during the competition, the Head Judge may excuse the dog from competing. The Head Judge must report any dog excused from competition on NAFA[®] Form C.12. The Head Judge is responsible for sending the completed form to the NAFA[®] corporate address within ten days of the incident. Ordinarily, the Regional Director and dog owner/ handler (and/or club owner) should receive a copy of the incident report at the tournament. In the event that this becomes impracticable, copies shall be distributed to those individuals within ten days of the incident.

(a) Review Process -- Once received by NAFA[®], the completed C.12 form shall be distributed to a Review Panel consisting of the Executive Director, the Chair of the Board of Directors, and the Chair of the Judges Committee. Members of the Panel shall be impartial and shall have no conflict of interest with the dog owner or any other party involved (e.g. shall not have family or club ties with the dog owner or any other party involved). If the form does not comply with the rules, it shall be returned to the Head Judge, dog owner, and Regional Director with

the deficiencies noted. Any deficiencies must be cured by the Head Judge within ten days of receipt. At the time that the Review Panel accepts the aggression excusal, it will send written notice to the dog owner (and/or club owner).

(b) Appeal -- Any appeal by the dog owner of an aggression excusal must be submitted in writing to the Review Panel (Executive Director, Chair of the Board of Directors, and Chair of the Judges Committee or their substitutes if a conflict exists) within 30 days of notification by the Review Panel. If any appeal is filed, a copy must be provided to the Head Judge. The Review Panel's decision to sustain an aggression excusal is final. The Review Panel's decision to overrule an aggression excusal expunges that excusal. The Review Panel shall issue a report at the next meeting of the Board of Directors regarding any aggression excusals received and any action taken for inclusion in the meeting minutes to be published on the NAFA[®] web page.

(c) Removal of Excusal -- A dog with one excusal for aggression may submit a request to have that incident removed from their record. The request must come no earlier than 3 years from the date of excusal and the dog must have participated in a minimum of 10 weekends of tournaments since its excusal with no further incidents. The request shall be submitted in writing to the Disciplinary Committee. The Disciplinary Committee will make a formal recommendation to the Board of Directors regarding a request for removal. A majority vote of the Board is required to sustain a removal. A dog may have only one aggression excusal removed.

(d) Penalty -- A dog will be barred from future competition immediately upon the second excusal for aggression. Any dog listed on a timesheet at a subsequent tournament after receiving a second aggression excusal will result in the penalties set forth in Section 7.6 - Penalties for Ineligible Dogs Running.

(e) Reinstatement Process -- An application for reinstatement may be submitted after a period of one year. The application should be submitted in writing to the Disciplinary Committee. The Disciplinary Committee will make a formal recommendation to the Board of Directors regarding a request for reinstatement. A majority vote of the Board is required to reinstate a dog. No more than one request for reinstatement may be filed in one year. In the event that a reinstated dog has an additional aggression excusal, the dog will immediately be barred from future competition and no further requests for reinstatement will be permitted.

Section 5.8 – Publishing of Disciplinary Action

NAFA[®] will publish on the website all individuals, dogs, and/or clubs that have disciplinary actions in effect against them, to include the name, effective date, action taken, and offense while the punishment is in effect.

CHAPTER 6 – HOSTING A NAFA[®] SANCTIONED EVENT

Section 6.1 – Requirements

(a) NAFA[®] sanctioned tournaments may only be hosted by NAFA[®] or NAFA[®] registered clubs in good standing. The host club must follow current NAFA[®] Rules of

Racing and Corporate Policies & Procedures. Any Club in good standing may be considered for sanctioning. At least fifteen days prior to the start of a tournament held in the United States, the NAFA[®] Tournament Sanctioning Secretary must receive a certificate of insurance listing NAFA[®] as an additional insured for that tournament with limits of at least \$1 million per occurrence. In the event the Tournament Sanctioning Secretary does not receive a certificate of insurance with coverage as stated above, the tournament sanctioning will be revoked. The first Club to apply for sanctioning with a valid sanctioning request will receive sanctioning unless the weekend meets the criteria for a reserved weekend by another Club.

(b) Reserved Weekends

(i) A Club establishes a reserved weekend by hosting a tournament on the same weekend number at the same venue for two consecutive years.

(ii) NAFA[®] will assign weekend numbers with weekend number one starting with the first Friday in the month of October.

(iii) The maximum number of weekends a Club may have reserved is two per NAFA[®] Racing year.

(iv) A Club loses its reserved weekend status when the Club fails to hold a tournament on the same weekend number at the same venue for two consecutive years.

(v) Clubs with reserve weekends must apply for sanctioning a minimum of 25 weeks before the tournament weekend. After the 25 week deadline, any Club per paragraph (a), above, may receive sanctioning.

(vi) Reserved Weekends cannot be transferred to another Club. The first club listed as host flyball club on the valid sanctioning request will be considered the host flyball club for reserved weekend purposes.

(c) NAFA[®] will only consider valid sanctioning requests two years in advance of the tournament date.

(d) NAFA[®] is committed to maintaining Flyball as a sport for all dogs. NAFA[®] tournaments are open to all dogs without regard to whether the dog is a mixed breed, a pure bred or any particular breed. NAFA[®] will not sanction a tournament at a site that excludes dogs on the basis of breed unless the exclusion is mandated by governmental law or ordinance and the host club has attempted and been unable to qualify for an exemption to governmental exclusions. A host club shall inform NAFA[®] of any such laws or ordinances when sanctioning is requested. It is the host club's responsibility to keep the sanctioning request current on all legislation and ordinances that affect the tournament. The host club shall finalize all such event limitations 60 days prior to the event closing.

(e) Applications for sanctioning of tournaments must be received by NAFA[®] at least thirty (30) days prior to the closing date.

(f) NAFA[®] will not sanction a tournament within 200 road miles of a previously sanctioned NAFA[®] tournament, without written approval from the sanctioned tournament's club owner.

(g) The host club must submit a complete application (NAFA[®] Form C.3). The entry fee shall be stated on a per team basis. The host club must request and obtain written approval from NAFA[®] for any special or unusual request.

(h) Tournaments will not be sanctioned by NAFA[®] where a permanently covered dirt racing surface is commonly used for housing cattle, swine, or poultry.

(i) All seeding and placing of teams in divisions is to be approved by the Regional Director.

(i) Whenever it is necessary to seed a division of fewer than 4 teams, the division shall be combined with an adjacent division for race scheduling purposes, unless permission is received from the Executive Director. If an elimination format is used, the divisions shall not be combined for that portion of the schedule. Division placements and breakout times for each individual division still apply.

(ii) The Regional Director shall receive seeding, a proposed schedule and tournament formats from the Tournament Director no later than 10 calendar days before the tournament. Failure to comply with this requirement shall result in a penalty of \$50.00 (USD or CDN) to the host club, unless the Executive Director approves an extension due to extenuating circumstances.

(j) All clubs registered with NAFA[®] are to be notified of the date, time and location of the tournament, and the name and phone number of the contact person, prior to the closing date.

(k) Limited Classes: A tournament may be sanctioned with some classes limited and others unlimited. At sanctioning, the host club must designate the classes offered and their limits, if any. The host club may not limit any class to fewer than four teams. Seed times for teams in limited classes are not required until the team is accepted into the class via random draw or otherwise. The host club must accept all entries up to 6:00 p.m., local time of the tournament secretary, on the closing date. Entries will be selected into a class by random draw when entries for the class exceed the sanctioned limit. When entries for one or more classes exceed the sanctioned limit, and entries for one or more classes do not meet the sanctioned limit, the size of the classes that have excess entries will be expanded by the automated draw to add excluded teams up to the maximum declared total number of teams permitted in all limited classes.

(i) The Draw shall be conducted via the NAFA[®] website, using the online lottery system. The draw must take place within 72 hours of the closing date of the tournament. Teams are to be grouped into rounds – each round shall contain only one team from each club: the first round will contain one team from every club; the second round will contain one team from every club that has entered two or more teams; the third round will contain one team from every club that has entered three or more teams; etc., until all rounds are created. Teams will be randomly drawn from the first round, then the second round, etc., until the class is filled. The host Club (the Club that applied for sanctioning) will be the first team to be drawn during the first round (guaranteed one entry). Co-host Clubs are not guaranteed an entry. The remaining teams will also be drawn and given an alternate number, starting with alternate one until all rounds are drawn from and every team either is in the class or is given an alternate number. If the number of teams that enter the limited class is less than or

equal to the limit, then no draw is required and all teams gain entry into the class; however, clubs are to be notified and clubs must respond per (ii) and (iii).

(ii) Notification of the Draw: All clubs shall be notified of the results of the draw within 48 hours of the draw. Notification can be done by telephone, facsimile, email or posting to the host club's website.

(iii) Club Notification of the Team Entry: All clubs shall notify the host club of seed times of all teams entered and of teams they wish to withdraw within 96 hours of the draw. If a club withdraws a team that has gained entry into the class, an alternate team will be selected. Alternate teams will be selected based on the order of the draw.

(iv) If any limited class in an event requires a draw, then all limited classes in that event must be drawn.

(v) If the Executive Director determines that the draw was completed incorrectly, then the draw for the entire event will be repeated.

(l) Prize money for any one team may not exceed \$500.00 USD or \$600.00 CDN per event per day.

(m) The following items will be sent to NAFA[®] within 14 days after the tournament, via NAFA[®] approved courier:

(i) If results are submitted electronically:

(a) A recording fee of \$20 (US funds) per scored team for single day tournaments and \$30 (US funds) per scored team for tournaments lasting more than 1 day. Electronically filed data shall meet the criteria established by NAFA[®]. When multiple tournaments hosted by the same club occur on successive days, the full fee is due for the tournament with the largest entry and \$10 per team may be deducted from each additional tournament;

(b) Original C.2 (timesheets) must be retained by the host club for at least 1 year following the tournament.

(c) completed Jump Heights Form (NAFA[®] Form C.9);

(d) completed Tournament Results Form (NAFA[®] Form C.6).

(e) if applicable, any statements with respect to conduct prejudicial to the sport of NAFA Flyball;

(f) if applicable, any protest(s).

(ii) When results are not submitted electronically:

(a) A recording fee of \$25 (US funds) per scored team for single day tournaments and \$35 (US funds) per scored team for tournaments lasting more than 1 day.

(b) original time-sheets (NAFA[®] Form C.2);

(c) completed Jump Heights Form (NAFA[®] Form C.9);

(d) completed Tournament Results Form (NAFA[®] Form C.6).

(e) if applicable, any statements with respect to conduct prejudicial to the sport of NAFA Flyball;

(f) if applicable, any protest(s).

(n) The following penalties will be applied when recording fees, timesheets, jump height forms, and tournament results are not received by NAFA[®] within 14 days after a tournament:

- (i) 15 plus days late, a fee of \$50.00 (USD or CDN) will be charged;
- (ii) one calendar month plus, a \$100.00 (USD or CDN) late fee will be charged;
- (iii) greater than two calendar months late and the club is put on probation for a period of 1 year;
- (iv) greater than three calendar months late and the club is suspended. Any suspended club would need to request reinstatement from the Board of Directors.

(o) Any tournament sanctioned by NAFA[®] must use a NAFA[®] approved Head Judge at the provisional level or higher.

(p) NAFA reserves the right to deny or revoke tournament sanctioning in the event that the tournament proposed would not be in the best interest of NAFA[®]. This includes, but is not limited to, sanctioning an event at the same venue, on the same weekend, as an event scheduled by another flyball sanctioning organization.

Section 6.2 - Classes of Competition

(a) NAFA[®] recognizes five classes of competition: Regular, Multibreed, Open, Veteran's and Non-Regular.

(b) The NAFA[®] Regular class of competition includes teams made up of any breed(s) of dog and/or mixed breeds and **must be offered at every sanctioned tournament.**

(c) A Non-Regular class (Pee-wee, four-of-a-kind, etc.), is any class other than the NAFA[®] Regular, Open, Veteran's or Multibreed class.

(d) In Multibreed competition, teams must consist of different breeds (minimum of 4, maximum of 6 with 4 different breeds running in a heat) recognized by any of the following Kennel Club's: American Kennel Club, Canadian Kennel Club, United Kennel Club, Mexican Kennel Club, American Rare Breed Association, American Herding Breed Association or a dog of mixed breeding.

(e) The Open Class is subject to all existing NAFA[®] Rules of Racing and Corporate Policies and Procedures except that the 87 day rule stated in Section 7.5(a) of the Corporate Policies and Procedures does not apply to the Open Class. The Open Class is subject to the following additional specific rules:

- (i) Other Classes or Time Sheets. A dog that is listed on a timesheet for a team in the Open Class may be listed on the timesheet for one additional team in another Class on the same day, except in circumstances where a second entry would be prohibited by Sections 6.2(f) or (g) of the NAFA[®] Policies and Procedures.
- (ii) Club Affiliation. A dog's club affiliation is not affected by reason of running in the Open Class.

(iii) Seeding. The preference for divisions comprising at least four teams shall not apply to the Open Class. In consultation with and with the approval of the Regional Director, the host club may utilize a racing schedule that has teams in the Open Class compete with teams in the Veteran's Class. Where this occurs in heats with direct competition between an open and a veteran team, the heat shall be run subject to the false start rule stated for the Veteran's Class in section 6.2(e)(i) and (ii) of the Corporate Policies and Procedures.

(iv) Record Times and NAFA[®] Seed Times. The rules governing world records stated in Section 7.2 of the Corporate Policies and Procedures do not apply to the Open Class. A team running in the Open Class is not eligible to set a NAFA[®] world record; Teams running in the Open Class shall be eligible for points and tournament placements within the Open Class. However, times set by a team running in a Open Class shall not be entered into the NAFA[®] Database as club or in region times. As with the Veteran's Class, a separate roster may be established on the website to report times for teams competing in the Open Class.

(f) In the Veteran's class, every dog on the team must be at least 7 years old. The Veteran's class shall be subject to the following additional rules:

(i) Race Schedule. The race schedule in the Veteran's class shall not call for more than a total of 16 possible heats per day, and the racing format shall not include a 5/5 or more strenuous format;

(ii) False Starts. In the Veteran's class, in the event of a false start as defined in Rule 8.3(b)(1) of the Rules of Racing, the heat shall not be restarted but the heat shall continue to be run. For the team to finish the heat, the dog that committed the false start must run again as the fifth dog in the heat;

(iii) Jump Heights. In the Veteran's class, jump heights shall be set at the minimum height stated in Rule 8.2(a) of the Rules of Racing, without regard to the height of the racing dogs.

(g) No dog shall be listed on more than one time sheet in any given class of competition. A dog listed on a time sheet in the Veteran's class at a tournament may not be listed on a time sheet for any other class of competition in that tournament unless the classes are scheduled so as to be run on separate days to a maximum of one additional class.

(h) Dogs may not compete in more than one class at a NAFA[®] sanctioned tournament except:

(i) When the tournament's regular class is unlimited or;

(ii) When all entries received for a tournament's limited entry regular class are accepted at the conclusion of the automated draw.

Section 6.3 – Format & Schedule

(a) The Regional Director shall approve the tournament format and schedule. The approved format and schedule shall be available to the Head Judge and all teams entered in the tournament no less than 48 hours prior to the competition. Failure to comply with this

requirement shall result in a penalty of \$50.00 (USD or CDN) to the host club unless the Executive Director approves an extension due to extenuating circumstances.

(b) The tournament format includes:

- (i) Teams in each division along with the seed time of each team and the breakout time assigned to that division.
- (ii) Format of the tournament, i.e., Round Robin with or without Single/Double elimination, and whether the two rounds are added together or not.
- (iii) Scoring – how wins and placements are determined; and how tie scores would be broken.
- (iv) The Race Schedule shall not call for more than a total of 35 possible heats per day per team.

Section 6.4 - Seeding

(a) Tournaments will be seeded by the times submitted with the team's entry. Multiple entries from the same club for the same class may not use the same seed times. After the closing date, the tournament director will divide the entered teams into divisions. Each division's breakout time will be one (1) second faster than the top team's seed time. Except in Division 1, a team running more than one (1) second faster than the top team's seed time will "breakout" of the division and be declared the loser of the heat. If the Electronic Judging System fails, or is not used this rule does not apply. **NOTE:** Tournament time sheets should be marked BO and indicate a loss – the time should still be recorded for the awarding of NAFA[®] points..

Section 6.5 – Electronic Judging Systems

(a) If there is a shortage of available EJS's for a tournament date, the repeat tournament dates have priority.

(b) If NAFA[®] owned EJS systems are not available, NAFA[®] will pay \$200.00 USD or CDN to rent a privately owned EJS system, if applicable. NAFA[®] will repair any damage to the EJS incurred during the actual tournament for which the EJS was rented by NAFA[®]. Damage reports are to be written by the Regional Director, and forwarded to the Executive Director.

(c) NAFA[®] owned EJS systems may be rented from NAFA[®] for \$200.00 USD (provided they are not required at a NAFA[®] Sanctioned tournament), plus the cost of shipping one way. Clubs using NAFA[®]'s EJS for demos are liable for all damages that occur during the demo and the shipping from the demo.

(d) Tournaments that generate less than \$200.00 USD in NAFA[®] fees will pay NAFA[®] \$200.00 USD to cover shipping costs. Tournaments that generate \$200.00 USD or more in NAFA[®] fees will receive one set of EJS lights at no additional charge. Tournaments that generate \$800.00 USD or more in NAFA[®] fees are eligible to receive two sets of EJS lights at no additional charge. Tournaments that generate \$1400.00 USD or more in NAFA[®] fees may be eligible to receive three sets of EJS lights.

(e) NAFA[®] EJS shall be shipped out by the host club the day after the completion of the tournament. If the NAFA[®] assigned carrier is closed the day after the tournament, the EJS must be shipped out at the next available day.

(i) A \$100.00 USD fine will be imposed on the host club, if EJS is not shipped out the next available day following the completion of the tournament.

(ii) A \$250.00 USD fine will be imposed on the host club, if EJS is not shipped out the next available day following the completion of the tournament and affects the next tournament.

CHAPTER 7 – STANDING RULES OF COMPETITION

Section 7.1 – Height Cards

(a) Height cards are optional. A dog's owner can apply to NAFA[®] for a height card application one (1) year after the dog has earned NAFA[®] points. Applications for height cards, along with the fee listed in Appendix A, must be applied for through the NAFA[®] mailing address. Each application will be embossed with the corporate seal and numbered. Applications must be presented to the measuring recorder before the dog is measured and the Measuring Head Judge must be notified that the height is being recorded for a height card prior to measuring the dog. All dogs will need three (3) matching measurements from three (3) different approved NAFA[®] judges. At least one (1) of the three (3) judges must be a NAFA[®] designated Supervising Head Judge. Only one height card measurement may be attained per tournament. Apprentice and Provisional Judges shall not measure for Height Card Application Forms (C.10).

(b) Height cards issued by NAFA[®] will be wallet-size cards. Handlers who forget their height cards at any given tournament may have their jump height contested. Completed height card forms are not accepted in lieu of a jump height card.

(c) Once a height card has been issued, additional cards for the same dog may not be applied for. Lost height cards can be replaced with an identical card for the fee listed in Appendix A. At the discretion of the Board, height cards may be reissued to accommodate rule or design changes.

(d) A height card is not subject to challenge except as provided below:

(i) A height card may be challenged once within a three (3) year period.

(ii) An Approved or Supervising Judge may challenge a maximum of three (3) height cards per fiscal (racing) year. To bring a challenge, the Judge must witness the dog competing while officiating.

(iii) A Club Owner may challenge a maximum of two (2) height cards per fiscal year. A Club Owner may only bring a challenge against dogs that the Club Owner witnessed competing at a NAFA[®] sanctioned tournament at which the Club Owner's club was also competing.

(iv) A Judge or Club Owner who wishes to bring a height card challenge must complete form C20 and submit it to the Executive Director no more than fourteen (14) days after

the last day of the event at which he or she witnessed the dog competing. If the form is mailed, it must be postmarked or email dated within the fourteen-day period. A Club Owner challenge must also be accompanied by a \$100.00 USD fee.

(v) If upon receipt of the C20 form and the fee (if required) the Executive Director finds that the challenge does not meet submission requirements or that there is currently a challenge in process, the challenger will be notified and the challenge fee (if any) will be returned.

(e) The Challenge Review Process

(i) If the challenge meets the submission conditions, the Executive Director shall, within 10 calendar days, notify the dog's owner by postal mail that the dog's height card has been challenged.

(ii) The dog's owner has ninety (90) days, from the postmark date of the notification letter to provide a video to the Executive Director showing the dog being measured by a NAFA[®] approved Head Judge during a sanctioned tournament. The dog is not required to participate in the tournament where it is measured. The owner may provide multiple videos.

(iii) Video Requirements:

a. The video must be recorded after notification of the challenge by the Executive Director.

b. The video shall have audio. The audio shall, at minimum, contain the measuring judge voicing:

1. The measuring judge's name
2. Date of the measure
3. Location of the measure
4. Height measured to the nearest 1/16"

c. The video will provide an unobstructed view portraying that the stand is in compliance with the Rules of Racing, Chapter 4 Measuring

d. Failure to provide a video within the allotted time will result in height card revocation.

e. The following video formats are acceptable; VHS, DVD, electronic file in .avi or .mpg format, or other pre-approved format.

(iv) Upon receipt of the video, the Executive Director shall distribute it to a Review Committee. The committee shall review the video within ten (10) days of receipt of the video.

(v) Review Committee;

a. A Review committee of 3 will be formed for each height card challenge.

b. Members of the committee shall be impartial and shall have no conflict of interest with either the challenger or dog owner (e.g. shall not have family or club ties with either the challenger or dog owner).

c. Members of the committee shall be selected as follows:

1. The Executive Director shall appoint an Approved Judge.
2. The Board of Director's Judge's Committee shall appoint an Approved Judge.
3. The two appointed members shall appoint a third Approved Judge and notify the Executive Director and Judge's Committee of their choice.

- d. The committee will work within executive session. Notes will not be published.
- e. The committee shall review the video and make one of three findings. They will report their findings to both the Executive Director and the Judges' Committee:
 - 1. The video is unacceptable for the purpose intended and what its deficiencies are
 - 2. The video is acceptable and is consistent with the issued height card and recommends that the height card be upheld
 - 3. The video is acceptable and is not consistent with the issued height card and recommends that the height card be revoked
- f. A video that is visually unclear, audio is vague, camera positioned poorly, etc., or the measure does not comply with the Rules of Racing are some of the reasons a video may be deemed unacceptable by the committee.

- (vi) The Executive Director shall implement the recommendations of the Review committee within 10 calendar days of the receipt of the committee's assessment by:
 - a. Notifying the dog owner that the first video was unacceptable with an explanation of its deficiencies and an acceptable video is required within 90 days. If an acceptable video has not been submitted within the extended 90 day period, the height card will be revoked.
 - b. Notifying the dog owner and challenger in writing that the height card has been upheld or revoked.

(f) Height Card Revocation: NAFA[®] will publish all revoked height cards. No other penalties shall be pursued other than revocation of the height card when a challenge is made to a height card.

Section 7.2 – Record Times

(a) To verify a new NAFA[®] World record time the judge must verify the following using NAFA[®] form C.13: Race lane length, jump placement, box throw, jump heights, and height dog measurement.

(b) Video recorded record breaking times shall be reviewed by a minimum of two neutral members of the Board of Directors. The video must be set on the starting line. The Head Judge must also verify the measurements of the lane, the height dog, and the Flyball box. Only video recorded record breaking times can be verified by the Board of Directors. Record breaking times not recorded on video in the described manner will not be recognized as a NAFA[®] record.

(c) Performance Teams and teams competing in the Open Class are not eligible for records times.

Section 7.3 – Racing Year

NAFA[®]'s racing year is October 1st through September 30th.

Section 7.4 – Meaningless Heats

Heats that are meaningless to the outcome of a sanctioned tournament are not to be run just for the sake of allowing teams to accumulate more points toward flyball titles.

Section 7.5 – Changing Clubs

(a) If a dog has earned points with a NAFA[®] Club in a NAFA[®] sanctioned tournament, the dog may not be listed on a timesheet for any other class other than the Veterans or Open class with a different NAFA[®] Club for a period of 87 days. The 87 day wait period shall begin the day after the end date of the last day of a tournament in which the dog earned NAFA[®] points. The dog will be eligible to be listed on a timesheet with a different club in a class of competition that starts the day after the 87 day waiting period. A dog must be eligible to race at the beginning of a class of competition to be included on the time sheet. Any dog(s) listed in violation of this rule will cause the forfeiture of all NAFA[®] points earned during the tournament for all dogs on the timesheet. The team with the dog violating this rule will also forfeit any tournament placement.

(b) The 87 day rule stated in paragraph 7.5 (a) above does not apply to the Veterans or Open classes. A dog running in the Veterans or Open class shall retain its existing club affiliation.

(c) Performance Teams may include dogs that otherwise would be ineligible to compete because the dog earned points on another club's team within the preceding 87 days, as prohibited in subsection (a) above. This exception is subject to the following terms, conditions and requirements:

(i) NAFA[®] Rules and Policies Apply. Clubs, teams, dogs and participants on Performance Teams remain subject to and governed by all of the provisions of the NAFA[®] Rules of Racing and Corporate Policies and Procedures, except as specifically set forth below.

(ii) Conversion to Performance Team Entry. With the permission of the Tournament Director for cause shown, a team entered in a regular or non-regular class may be converted from its original status to a Performance Team entry prior to the start of the tournament. The intent of this conversion privilege is to allow teams that have already entered a tournament but who, for unforeseen reasons, find themselves unable to field a complete team, to run for points with a dog or dogs from another club. "Cause" shall include but not be limited to circumstances such as dog injury, illness, or other unforeseen situation. A team may not enter a tournament as a Performance Team.

(iii) Performance Team Status Declared. A team's status as a Performance Team entry shall be clearly shown on the team's time sheet and declared prior to the start of racing. The team's status as a Performance Team shall be disclosed on the seeding list prepared and circulated by the host club prior to the tournament and/or at the captain's meeting before the racing starts. Once a team is declared to be a Performance Team, its status does not change, even if the non-club dog(s) listed on the time sheet do not earn any points.

(iv) Club Affiliation. A dog's club affiliation is not affected by reason of running on a Performance Team.

(v) Other Classes or Time Sheets. A dog that is listed on a timesheet for a Performance Team may be listed on the timesheet for one additional team provided the entry is on a team in another class, except in circumstances where a second entry would be prohibited by Sections 6.2(f), (g) or (h) of the NAFA[®] Policies and Procedures.

(vi) Placements and Awards. A Performance Team is not eligible for tournament awards or placements. A Performance Team will not be awarded any wins in any races or heats. A team racing against a Performance Team must complete the minimum number of heats in order to record a win. In an elimination event, Performance Teams shall be placed at the bottom of the elimination brackets, with the Performance Teams being ranked by time among themselves by seed time in the event more than one Performance Team is in the elimination schedule.

(vii) Record Times, NAFA[®] Seed Times, and Championships. A Performance Team is not eligible to set a NAFA[®] world record. The rules governing world records stated in Section 7.2 of the Corporate Policies and Procedures do not apply to Performance Teams. Times set by a Performance Team shall be recorded on the time sheet for purposes of calculating points earned by the dogs on the timesheet entered into the NAFA[®] Database but for no other purpose. Regardless of the regional affiliation of the club fielding the Performance Team, such teams shall be treated as out of region teams for purposes of the Rules governing Regional Championships.

Section 7.6 – Penalties for Ineligible Dogs Running

Any dog(s) listed on a time sheet in violation of Chapters 3 and 7(d) of the Rules of Racing, sections 6.2(g) and (h) and 7.5 of the Corporate Policies and Procedures and any appendices pertaining to eligibility will cause forfeiture of all NAFA[®] points earned during the tournament for all dogs on the team(s) on whose time sheet(s) the ineligible dog(s) appear. Team(s) with dog(s) violating these rule(s) will also forfeit any tournament placements. Failure to record a jump height on a C.2 form alone does not trigger the penalties specified in this section and does not require the forfeiting of heats.

When a violation is discovered during a tournament, the offending team will be deemed to have declared itself For Exhibition Only from that point forward. Races completed before the violation is discovered will not be rescored, but all future races will be scored as losses.

CHAPTER 8 – AWARDS

Section 8.1 - Points

Each time a team races in a NAFA[®] sanctioned Flyball tournament with a recorded time under 24 seconds, each dog racing in that heat will receive 25 points toward a Flyball title; under 28 seconds each dog racing in that heat will receive 5 points; under 32 seconds each dog racing in that heat will receive 1 point; provided that a NAFA[®] judge is present and at least four teams compete. Each of the four teams must actually compete. All four teams may be from the same club provided each team registered with NAFA[®] was given an equal opportunity to enter, but chose not to.

Section 8.2 - Titles

- (a) NAFA[®] will award a certificate of achievement and the title Flyball Dog (FD) to any dog receiving 20 points.
- (b) NAFA[®] will award a certificate of achievement and the title Flyball Dog Excellent (FDX) to any dog receiving 100 points.
- (c) NAFA[®] will award a certificate of achievement and the title Flyball Dog Champion (FDCh) to any dog receiving 500 points.
- (d) NAFA[®] will award a certificate of achievement and the title Flyball Dog Champion-Silver (FDCh-S) to any dog receiving 1,000 points.
- (e) NAFA[®] will award a certificate of achievement and the title Flyball Dog Champion-Gold (FDCh-G) to any dog receiving 2,500 points.
- (f) NAFA[®] will award a certificate of achievement, a commemorative pin and the title Flyball Master (FM) for any dog receiving 5,000 points.
- (g) NAFA[®] will award a certificate of achievement, a commemorative pin and the title Flyball Master Excellent (FMX) for any dog receiving 10,000 points.
- (h) NAFA[®] will award a certificate of achievement, a commemorative pin and the title Flyball Master Champion (FMCh) for any dog receiving 15,000 points.
- (i) NAFA[®] will award a commemorative pin, plaque and the title "Onyx", named after its first recipient, for any dog receiving 20,000 points.
- (j) NAFA[®] will award a commemorative pin, plaque and the title Flyball Grand Champion (FGDCh) for any dog receiving 30,000 points.
- (k) NAFA[®] will award a commemorative pin and plaque for any dog receiving 40,000 points.
- (l) NAFA[®] will award a commemorative pin and plate for the 40K plaque at each 10,000 increment from 50,000 through 90,000 points.
- (m) NAFA[®] will award a commemorative pin, plaque and the title "Hobbes Award" named after its first recipient, for any dog receiving 100,000 points.

Section 8.3 - Regional Champions

- (a) At the end of each racing year, NAFA[®] will name Regional Champions in the Regular and Multi-Breed Classes for each region and commemorate this achievement by awarding a plaque. Second and third place clubs in the Regular and Multi-Breed Classes for each region will be recognized by awarding a certificate. Regional Champions are determined by points earned by a Club during the racing year and, in appropriate cases, by the tie-break formula set out below.

(b) A Club that is not in good standing at any time during the racing year is not eligible to be named Regional Champion.

(c) All points and tie-break times for Regional Championships must be earned in the Club's home region, i.e., an "in-region" team. A Club's home region, absent a written request for change, is the place of residence of the Club owner shown on NAFA[®] Form C.11. A Club may change regional affiliation by written request to NAFA[®]. Requests to change regional affiliation to an adjacent region must be received before the start of the racing year to take effect that year. A host club's regional affiliation shall determine the region in which regional points accrue for tournaments hosted by that Club.

(d) Points towards Regional Championships accrue to a Club. Only one team from each Club will qualify for Regional Championship points in the same Class at a tournament (i.e., clubs fielding more than one team in a Class may not count points accumulated from both teams in that Class towards the Regional Championship). A Club fielding teams in both the Regular and Multi-Breed Classes of competition may, however, accumulate points in each separate Class.

(e) A Club must compete in a minimum of four tournaments in separate tournament weeks within its home region in the Class for which the Regional Championship is awarded. Classes must meet the following criteria to qualify for points and/or tie-breaking times to count toward Regional Championships:

- (i) Classes must have a minimum of four teams competing;
- (ii) Regular Classes limited below 20 teams that exclude a team at the conclusion of the automated draw will not count towards Regional Championship points or tie-break times;
- (iii) Multi-breed Classes limited below 12 teams that exclude a team at the conclusion of the automated draw will not count towards Regional Championship points or tie-break times;
- (iv) In a limited entry class of competition, if any entering Club is excluded at the conclusion of the automated draw, the class of competition will not count towards Regional Champion points or tie-break times.

(f) Points towards Regional Championships are awarded based on overall placements of in-region teams in an event based on the following point structure, to maximum of 30 points:

Top Finishing Regional Team 3 points
2nd Place Regional Team 2 points
3rd Place Regional Team 1 point

As noted in paragraph 8.3(d) above, points are awarded to a Club and not its teams. Thus, if a Club finishes first and second in an event run in its home region, regional points are awarded as 3 points to the first place team and 1 point to the third place team from the different Club.

For regions that host 7 or fewer tournament weeks, regional points are to be accumulated from up to 80 percent of the tournaments regardless of the number of tournaments held per week. For example, if a region has a total of 10 tournaments in the racing year held on 5 tournament weeks, 80 percent of that would equal 8 tournaments. Points towards Regional Championships would count from the best 8 finishes for any given Club against in-region team competition.

When a region hosts events in more than 7 tournament weeks, a Club will earn regional points from up to 80 percent of the tournament weeks in that region based on the Club's best finish from any event to a maximum of 10 tournaments held in separate tournament weeks. In the case where multiple events exist in a tournament week, regional points are still awarded based on in-region placement within each tournament. When regional points are not awarded due to a Club's prior win in the same week, the points will not be awarded to teams finishing lower in the tournament. For example, if a Club finishes first on each day, then the fastest time will be used for that Club's regional points but no first place points will be awarded on the second day as the winner has blocked out the win from other Clubs.

If there are 7 or less tournament weeks in a racing year for the region, then points are awarded from tournaments regardless of the number of tournaments in a tournament week, so a club could receive multiple points from multiple locations.

(g) In the case of a point tie, the best times from each Club's four (4) best in-region tournament placements will be averaged. For example, if a Club places second in a tournament, but has four other in-region tournament wins, the times from the tournament wins will be used in the average, regardless of how fast a time was run to achieve the second place result. The Club with the lowest average time will be named the Regional Champion. If a tie still exists after the tiebreaker is exhausted, Co-Champions will be named.

(h) If a Club disbands before the end of a racing year, it is not eligible to win a Regional Championship.

Section 8.4 – NAFA[®] Champions

(a) The NAFA[®] Champions will be named from among the Regional Champions.

(b) A minimum of six (6) tournaments must be entered, regardless of their location, to qualify for the NAFA[®] Championship. Of all tournaments entered in any competition year (inside or outside of a team's region), the six (6) fastest times from the Club's best team placements will be averaged. The Club with the lowest average time will be named NAFA[®] Champions. If a tie exists, Co-Champions will be named.

Section 8.5 – Clyde Moore Memorial Hall of Fame

NAFA[®] may induct two dogs per year into the Hall of Fame. Using the following criteria, individuals are asked to nominate candidates that they consider deserving of this award using

form C.7 or equivalent information. Each nominee may only be nominated by one person in each election.

(i) Longevity: A dog must have raced in NAFA[®] sanctioned events for a minimum of four (4) years;

(ii) Notoriety: How well known is this dog? Nominees should be easily recognizable within their own racing area;

(iii) Team value: What is the worth of this dog to its team, i.e. untiring start dog, height dog, most consistent dog, fast anchor dog. Although other titles and achievements may be included in the nomination, each dog will be judged on the above Flyball criteria only.

(iv) Also, in order to be inducted into the Hall of Fame a dog must have 35% or more of the ballots returned and validly voted.

Submit a brief resume of two hundred (200) words or less to include the dog's name, CRN Number, breed, clubs raced with, and the reasons he or she deserves consideration.

Each year all candidates will be judged by NAFA[®]'s Board of Directors in order of merit. A list of no more than five (5) finalists will be selected and put to a delegate vote.

Submit nominations to NAFA[®] no earlier than June 1st and no later than July 31st of each year by mailing to the Hall of Fame Committee at the published NAFA[®] address. Submissions may be made by mail, fax or electronically. NAFA[®] encourages anyone who feels that they have a dog worthy of recognition to keep photographs.

Section 8.6 – Regional MVP Award

(a) This award is given to the dog deemed to be most valuable in its specific region for the current racing year. To be eligible, the dog must have earned NAFA[®] points in that region during the current given racing year. Only one candidate will be given this award per year, per region. Each nominee may only be nominated by one person in each election.

(b) Nominations must come from a club in the candidate's region using form C.7 or equivalent information. Nominations shall be no more than 200 words, citing the contribution and outstanding qualities that make the candidate deserving of the award. Candidates cannot have previously won the award. Nominations should be sent to the NAFA[®] mailing address. Submit nominations to NAFA[®] no earlier than June 1st and no later than July 31st of each year by mailing to the Hall of Fame Committee at the published NAFA[®] address. Submissions may be made by mail, fax or electronically.

(c) A committee shall be appointed by the Board of Directors, and chaired by a member of the board. This committee will review the nominations and ensure they meet the above nomination criteria. All qualified nominations will be put to ballot vote.

(d) In conjunction with annual delegate voting, voting sheets will go out to delegates with only those candidates in their region. Delegates may vote for only one candidate. All votes must be returned in conjunction with deadlines set forth in the Hall of Fame voting.

(e) The winning candidate will be that candidate that earns the most returned votes from its region. Winners will be announced at the Annual General Meeting.

Section 8.7 – Judge of the Year Award

(a) This award is to recognize a NAFA[®] judge who shows dedication, knowledge, sportsmanship, and outstanding contribution to the sport. The award may be given to one judge in each racing year. To be eligible, the judge must be a current NAFA[®] judge at the approved level or higher. The judge must be in good standing with NAFA[®] and must have been a judge for at least five years at the time of nomination.

(b) A nomination may be made by any person in good standing with NAFA[®]. Each nominee may only be nominated by one person in each election. The Board of Directors will narrow the list of nominees to no more than five (5) finalists to submit to a delegate vote.

(c) Nominations shall be no more than 200 words, citing the contribution and outstanding qualities that make the candidate deserving of the award. Candidates cannot have previously won the award in the past five years. Nominations should be submitted via the NAFA[®] webpage or sent to the NAFA[®] mailing address. Submit nominations to NAFA[®] no earlier than June 1st and no later than July 31st of each year. Submissions may be made by mail, fax or electronically.

(d) A committee shall be appointed by the Board of Directors, and chaired by a member of the board. This committee will review the nominations and ensure they meet the above nomination criteria.

(e) The winning candidate will be the candidate who earns the most returned votes. Winners will be announced at the Annual General Meeting.

CHAPTER 9 - CONFLICT OF INTEREST POLICY

No NAFA[®] Executive Director, Member of the Board of Directors or Regional Director may have a significant interest in any other Flyball event-giving organization deemed by the NAFA[®] Board to be in competition with the North American Flyball Association[®].

“Significant Interest” is defined as ownership of, a directorship in, holding office in, employment by, under contract to, listed as a Tournament Director, Tournament Secretary or as Head Judge for an event sanctioned by such a competing organization.

Compliance with the NAFA[®] Conflict of Interest Policy shall be one of the eligibility requirements for service on the NAFA[®] Board, as set out in Article IV, Section 3 of the By-Laws; violation of this Policy by a Board Member shall constitute grounds for removal from the Board pursuant to Article IV, section 17 of the By-Laws.

Compliance with the NAFA[®] Conflict of Interest Policy shall be one of the eligibility requirements for service as a NAFA[®] Regional Director, as set out in Chapter 1, Section 1.6 (b) of the Corporate Policies and Procedures. Violation of this Policy by a Regional Director shall constitute grounds for removal from this position pursuant to Chapter 5, Section 5.6 (b) of the Corporate Policies and Procedures.

NORTH AMERICAN FLYBALL ASSOCIATION, INC.®

BYLAWS

These Bylaws govern the affairs of the North American Flyball Association[®], a nonprofit corporation organized under the Michigan Nonprofit Corporation Act (the "Act").

ARTICLE I - OFFICES

The principal office of the Corporation shall be located at 1333 W. Devon Avenue, Box 512, Chicago, Illinois 60660, or such other place as the Board of Directors may determine. The Corporation may have such other offices, either within the State of Illinois or elsewhere, as the Board of Directors may determine or the business of the Corporation may require. The Board of Directors may change the location of any office of the Corporation.

ARTICLE II - PURPOSE

The purpose for which NAFA[®] was formed is to promulgate rules for amateur Flyball competition, to train and approve judges, to sanction amateur Flyball tournaments, to promote interest in the sport of Flyball, to encourage national and international amateur Flyball competition and to recognize excellence. The Corporation is a nonprofit, qualified amateur sports organization.

ARTICLE III - MEMBERSHIP

The Corporation will have no members.

ARTICLE IV - BOARD OF DIRECTORS

Section 1. Powers. The business of the Corporation shall be managed by and under the direction of the Board of Directors, which may exercise all powers of the Corporation and do all such lawful acts and things not prohibited by statute or by the Articles of Incorporation or these Bylaws. In addition to the authority conferred by other provisions of the Bylaws, the Board of Directors may promulgate such rules, regulations and orders as they deem appropriate to carry out the provisions of the Bylaws or any other laws applicable to the activities of the Corporation.

Section 2. Number. The number of voting members of the Board of Directors shall consist of no fewer than nine (9) nor more than fifteen (15), unless pursuant to the Act and in accordance with these Bylaws such number is increased or decreased by amendment to these Bylaws. In no event, however, shall the number of Directors be less than three (3) and no decrease in the number of Directors shall have the effect of shortening the term of any incumbent Director.

Section 3. Eligibility. Directors shall meet the following eligibility requirements: (i) be an individual who subscribes to the purposes and goals of the Corporation, (ii) receive no compensation or honoraria from the Corporation for their Board duties except reimbursement for reasonable expenses as set forth in Corporate Policies and Procedures, (iii) not be related to nor living with another Director, (iv) be in compliance with the NAFA[®] Conflict of Interest Policy stated in Chapter 9 of the Corporate Policies and Procedures, (v) be an individual who has not immediately prior to his election served two full consecutive terms on the Board of Directors as provided in Sections 5 and 6 of this Article II; and (vi) shall be in good standing with the Corporation. Good standing shall be defined as current in all financial obligations to the Corporation and not currently under any disciplinary action (probation, suspension, etc.).

Section 4. Election of Directors. Except as expressly provided otherwise in these Bylaws, Directors and the Executive Director shall be elected for three-year terms by delegate vote under Article VII. Nominations for vacant or vacating positions must be received by the Nominating Committee no later than 11:59 PM Central Daylight Time on July 31. The Nominating Committee shall distribute a slate of qualified candidates for Directors and, when applicable, for the Executive Director at least sixty (60) days prior to the Annual General Meeting. The slate of nominated candidates shall appear on the NAFA[®] web page or shall be mailed to the delegate vote holders separately. Delegate vote holders shall be entitled, but not required, to cast as many votes for Directors as there are positions to be filled times the number of delegate votes held, but may cast no more than the number of delegate votes held for any single candidate. The candidate(s) for each office receiving the most eligible votes shall be deemed elected. Ballots will be counted at or before the Annual General Meeting by the Election Committee, or by an independent individual or organization retained by the Board of Directors to tabulate the ballots. If there is a tie in the vote for the position of Executive Director or in the vote for the last position on the Board of Directors to be filled, there shall be a runoff election between the tied candidates.

Section 5. Term of Office. Unless elected to fill a vacancy, each Director shall be elected to a three (3) year term. Terms of office shall be staggered so that approximately one third (1/3) of the board members'

terms will expire each year. No member of the Board of Directors may serve for more than two (2) full consecutive terms of office. Newly elected Directors shall commence their term of office at the conclusion of the Board meeting in which they are elected or confirmed, and terms will expire at the end of the meeting of the Board of Directors in the third year of the term at which the election of their successors is confirmed.

Section 6. Vacancies. Vacancies occurring as a result of the resignation, death or removal of a Director, or the expansion of the size of the Board, may be filled by nomination by the Chairperson followed by election by the Board. Any Director chosen to fill a vacancy in mid-term shall serve the remaining term of office for the directorship so filled. Any Director who fills a vacated position and serves for two years or greater, shall be considered to have served a full term for purposes of election eligibility.

Section 7. Annual Meeting. The annual meeting of the Board of Directors shall be held within the period between December first and January thirty-first inclusive at such time and place as shall be determined by the Board of Directors. At the annual meeting, the Board of Directors shall elect officers (other than the Executive Director) and conduct such other business as shall come before the meeting.

Section 8. Regular Meetings. The Chairperson of the Board may designate a time and specific location for regular meetings of the Board of Directors. The Chairperson shall preside over all Regular Meetings of the Board of Directors.

Section 9. Special Meetings. Special meetings of the Board of Directors may be called by the Chairperson of the Board, any two (2) officers, or any three (3) Directors. Such meeting shall be held on such date and at such time and place and for such purposes as shall be designated in the notice of the meeting by the person or persons calling the meeting. At a special meeting, the Board of Directors shall conduct only the business specified in the notice of the meeting.

Section 10. Open Meetings. Subject to Section 13 of this Article IV, meetings of the Board of Directors shall be open.

Section 11. Notice: Waiver of Notice. Written notice of the time and place of all regular, special, and annual meetings of the Board of Directors and of the purposes of special meetings shall be given to each Director at least five (5) days before the date of the meeting, either personally or by sending such notice by mail or electronic transmission to each Director at the address designated by the Director for such purposes, or if none is designated, at the Director's last known address. Notice of any meeting of the Board of Directors may be waived in writing before or after the meeting. Attendance at a meeting constitutes waiver of notice of the meeting.

Section 12. Quorum and Vote at Meetings. At any meeting of the Board of Directors, a majority of the Directors in office shall be necessary to constitute a quorum for the transaction of business. A majority of the votes cast at a meeting of the Board of Directors, duly called and at which a quorum is present, shall be sufficient to take and authorize action upon any matter which may properly come before the meeting, unless the concurrence of a greater proportion is required for such action by statute, the Articles of Incorporation or these Bylaws. Notwithstanding the preceding, the Executive Director may, in his discretion, require the vote of at least three quarters (3/4) of the Directors in office to take or to authorize particular actions coming before the Board of Directors, except amendment of these Bylaws as provided in Article IX. The Executive Director shall exercise the authority to require such a vote on any particular action at any meeting at which he is present or by written notice given to the Chairperson by mail or electronic transmission at least three (3) days in advance of the meeting. If, at any meeting of the Board of Directors, there shall be less than a quorum present, a majority of those present may adjourn the meeting without further notice, until a quorum shall be present. Subsequently, at any adjourned meeting at which a quorum shall become present, any business may then be transacted at the meeting as originally notified. Directors may not vote by proxy.

Section 13. Executive Session. The Board of Directors may adjourn to executive session at any time it deems in its discretion necessary or appropriate for the benefit of the organization. At the direction of the Chairperson of the Board, or upon the request of any two (2) Directors, a matter shall be discussed in executive session. Executive session shall be restricted to members of the Board of Directors, the Executive Director and any other such persons invited by the Chairperson. Failure to maintain the confidentiality of any executive session of the Board of Directors constitutes cause for removal of a Director.

Section 14. Telephone Meetings. Members of the Board of Directors or any Committee designated by the Board may participate in a meeting of such Board or Committee by means of conference telephone or

similar communications equipment by means of which all persons participating in the meeting can hear each other, with the advance approval of the Chairperson of the Board or Committee. Participation in a meeting pursuant to this Section shall constitute presence in person at such meetings and a waiver of notice of the meeting.

Section 15. Action by Unanimous Consent. Any action required or permitted to be taken at any meeting of the Board of Directors or of any Committee thereof may be taken without a meeting if a written consent, setting forth the action so taken, is approved in writing by all the members of the Board of Directors or the Committee, as the case may be, and such written consent shall have the same force and effect as a unanimous vote at a meeting of the Board of Directors or the Committee. A consent may be delivered by electronic transmission to the Secretary of the Corporation or to the Chairperson and shall be effective upon receipt. For approval of the minutes, unanimous written consent may be obtained by written notice setting a date allowing at least 7 calendar days by which the action will be deemed approved if not objected to in writing.

Section 16. Resignation and Removal of Directors. Any Director may resign at any time. Such resignation shall be made in writing and shall take effect at the time specified therein or, if no time is specified, at the time of its receipt by the Chairperson or Secretary. Directors may be removed with or without cause at any meeting of the Board of Directors duly called and at which a quorum is present, by the affirmative vote of two-thirds of the Directors then in office. Absence from more than one-third (1/3) of the meetings of the Board of Directors in any year constitutes cause for the removal of a Director.

Section 17. Compensation and Reimbursement. No member of the Board of Directors shall receive compensation for their Board duties except reimbursement for reasonable expenses by the Board as set forth by Corporate Policies and Procedures.

Section 18. Minutes. The Board of Directors shall keep minutes of all meetings of the Board of Directors and the proceedings thereof. The Board of Directors shall take appropriate action to cause the approved minutes of such meetings to be delivered upon receipt of written request for such minutes to the Secretary.

Section 19. Conduct of Meetings. Meetings of the Board of Directors and of Committees will be run substantially in accordance with Robert's Rules of Order, but the failure to comply with Robert's Rules of Order shall not invalidate any action otherwise duly taken. If the meeting is being tape recorded, speakers shall state their names before addressing the Chairperson. There shall be a policy of no smoking during all meetings.

ARTICLE V - COMMITTEES OF DIRECTORS

Section 1. Committees. In addition to the standing committees designated in this Article V (the "Standing Committees"), the Board of Directors may, by resolution, designate one (1) or more Committees of the Board which shall have such powers and duties as the Board of Directors may determine from time to time. Except as otherwise provided by statute, the Standing Committees shall have the powers and authority designated in this Article V and such additional powers and duties as the Board of Directors may determine from time to time. Each Standing Committee other than the Nominating Committee and each other Committee shall include at least one (1) Director. No Committee of the Board of Directors shall have the power to amend the Articles of Incorporation or the Bylaws of the Corporation. Non-directors may be appointed to the membership of Committees other than the Executive Committee and the Disciplinary Committee. The Chairperson of the Board shall appoint the Committees with approval of the Board of Directors and serve as a voting member of all Committees, except the Nominating Committee and, in a year in which the Chairperson is a candidate, the Elections Committee. The Executive Director shall be privileged to attend and to participate without a vote in the meetings of all Committees of which he is not otherwise a member.

Section 2. Standing Committees. Each member of the Board of Directors shall serve in some capacity on a Standing Committee. The Standing Committees of the Board of Directors shall be as follows:

(a) **Executive Committee.** The Executive Committee shall consist of the Chairperson of the Board, Vice Chairperson, Secretary, and Treasurer. The Executive Committee shall have and may exercise any and all power and authority of the Board of Directors in the management of the business affairs of the Corporation

(within the limits provided by law) when the Board is not in session, except over matters specifically retained by the Board by resolution or in these Bylaws.

(b) Finance Committee. The Finance Committee shall consist of the Vice Chairperson, the Treasurer and other appointees. The Vice Chairperson and Treasurer of the Corporation shall co-chair the Finance Committee. The Finance Committee shall have the power and authority to seek all possible funding sources for the Corporation; to review and recommend to the Board of Directors the engagement of the independent accounting firm; to review with independent accountants the fee, scope and timing of the services; to review with the independent accountants, upon completion of any annual review or audit, significant accounting adjustments, recommendations for improving internal controls and all other significant findings made during an audit or review; to meet periodically with the Corporation's management and accountants to discuss internal accounting and financial controls; to review and make recommendations on material contracts to which the Corporation is a party; to initiate and supervise any special investigation it deems necessary; to consult with the Corporation's management regarding, and to periodically review, the financial condition of the Corporation; and, if requested to do so by the Board of Directors, to work with the Executive Director and other Standing Committees to compile the annual budget of the Corporation for approval by the Board.

(c) Nominating Committee. The Nominating Committee shall not include members of the Board of Directors, candidates for office, or members of their households. The Chairperson of the Board shall appoint the Nominating Committee and its chairperson. The Nominating Committee shall have the power, authority and duty to notify the delegate vote holders of the ability to submit nominations, as appropriate, to fill Director positions; to provide a slate to fill vacating Director positions to the Board at least sixty (60) days prior to the Annual General Meeting; and to provide to the Board of Directors recommendations of names of people qualified to fill untimely vacancies on the Board of Directors. The Nominating Committee shall include in the slates of nominees to be presented for election to the Board of Directors and as Executive Director all individuals recommended by delegates that meet the eligibility requirements in Section 3 of Article IV.

(d) Rules Committee. The Rules Committee is charged with the upkeep, improvement and interpretation of the Bylaws, the Rules of Racing, and the Corporate Policies and Procedures. At least one Supervising Head Judge shall serve on the Rules Committee. All changes recommended by the Rules Committee to the Bylaws, the Rules of Racing, or the Corporate Policies and Procedures must be approved by the Board of Directors which may also, in its discretion, submit matters that affect the Rules of Racing or other matters as appropriate to delegate vote as provided in Section 5 of Article VII.

(e) Judges Committee. The Judges Committee shall develop and maintain a program for the training of judges and other individuals seeking information about the sport. This Committee shall oversee the planning of NAFA[®] sponsored educational seminars and workshops for the purpose of advancing the sport in areas where information is needed. This Committee shall also oversee the development of new NAFA[®] approved judges and recommend their approval.

(f) Marketing Committee. The Marketing Committee is charged with responsibility for publicity, promotion, advertising, opportunity development, public relations and developing all promotional materials.

(g) Election Committee. The Election Committee shall consist of at least three (3) persons of which at least two (2) shall be persons in good standing, holding no office within the Corporation and only one (1) shall be a current Board member not up for election. Individuals who are current candidates for election or re-election to the Board of Directors or Executive Director shall not serve on the Election Committee. The Election Committee shall receive completed ballots at or before the beginning of the Annual General Meeting and shall be responsible for verifying that all returned ballots are authentic and tallying the results (or for assisting the independent individual or organization retained by the Board of Directors in doing so) and reporting the results to the presiding officer of the Annual General Meeting. The Election Committee may dispose of the ballots after it has reported the results of the election and the Annual General Meeting has been adjourned.

(h) Disciplinary Committee. The Disciplinary Committee shall consist of at least three (3) members and shall consist solely of Board members. The Committee will consider all charges brought forward to the Board, gather information and consult all parties in the dispute and investigate the charges. The Committee will make a formal recommendation to the Board on actions for this dispute as well as recommendations to the Executive Director regarding any immediate action required.

Section 3. Tenure. Subject to the provisions of Section 7 and 8 of this Article V, each member of any Standing Committee or any other Committee shall hold office until his successor is designated by the Board

of Directors. The Chairperson of the Board shall appoint the chairpersons of each Committee, unless otherwise specified in these Bylaws.

Section 4. Meeting and Notices. Regular meetings of Committees of the Board of Directors may be held without notice at such times and places as such Committees may determine by resolution or by written notice from the Chairperson of the Board or the Chairperson of the Committee at least seven (7) days in advance of the meeting. Special meetings of Committees may be called by any member thereof upon not less than twenty-four (24) hours advance notice to each member of that Committee stating the place, date and hour of the meeting, which notice shall be given in the manner provided in Section 11 of Article IV hereof. Any member of a Committee may waive notice of any meeting thereof, either before or after the meeting, by signing a waiver of notice that shall be filed with the records of such meeting, or by attendance at such meetings.

Section 5. Quorum. A majority of the members of a Committee shall constitute a quorum for the transaction of business at any meeting thereof. The vote of a majority of the members of a Committee present at a meeting at which a quorum is present shall constitute action of the Committee.

Section 6. Action By Unanimous Consent and Telephone Meetings. Sections 14 and 15 of Article IV are hereby incorporated by reference into this Article V, and their provisions shall apply to all Committees and members of the Committees to the same extent that they apply to the Board of Directors and all Directors.

Section 7. Removal and Resignations. Any member of any Committee may be removed at any time with or without cause by resolution adopted by a majority of the Directors then in office. Any member of a Committee may resign from the Committee at any time by giving written notice to the Chairperson of the Board of Directors or the Secretary of the Corporation. Unless otherwise specified therein, such resignation shall take effect upon receipt thereof.

Section 8. Vacancies. Any vacancy occurring on any of the Committees of the Directors shall be filled by appointment of the Chairperson of the Board and ratified by the Board of Directors.

Section 9. Reports. The Chairperson of each Standing Committee or other Committee established by the Board of Directors shall report any actions taken or recommendations by the Committee to the Board of Directors at the next regular or annual meeting thereof held after the Committee action or meeting. The Secretary of the Corporation shall record the reports by Committee chairpersons in the Corporation's minutes.

ARTICLE VI - OFFICERS

Section 1. Positions. The officers of the Corporation shall be the Chairperson of the Board, the Executive Director, the Vice-Chairperson, the Secretary and the Treasurer, who shall exercise such powers and perform such duties as shall be determined in accordance with these Bylaws or by the Board. No person shall hold more than one office of the Corporation. The Chairperson, Vice-Chairperson, Secretary and Treasurer shall be elected by the Board of Directors from among its members. Newly elected officers (other than the Executive Director) shall commence their term of office at the conclusion of the Board meeting in which they are elected. The Executive Director shall be elected by delegate vote as provided in Section 4 of Article IV.

Section 2. Election, Term of Office and Vacancies. Each officer of the Corporation other than the Executive Director shall be elected annually by vote of a majority of the members of the Board of Directors then in office and shall serve for one (1) year or until his successor shall have been duly elected and qualified, or until his death, resignation or removal from office in accordance with these Bylaws. The Executive Director shall serve for a three (3) year term. Vacancies in the positions of officers may be filled by vote of a majority of the members of the Board of Directors then in office. Officers elected to fill vacancies shall serve the remainder of the terms of their predecessor, except that the Board of Directors may provide for the election of an Executive Director by the delegates in conjunction with a Board election held prior to the expiration of term of the former Executive Director. An Executive Director selected in such an election shall serve for a three (3) year term (and not for remaining portion of the term that became vacant).

Section 3. Chairperson of the Board. The Chairperson of the Board shall preside at and set the agenda for meetings of the Board of Directors, shall act as the chief executive officer of the Corporation, shall appoint Committee Chairpersons and members and Special Project Leaders as needed, and shall

exercise and perform such other powers and duties as may be assigned by the Board of Directors or by the Bylaws. The Chairperson shall carry into effect all orders and resolutions of the Board subject to the right of the Board by resolution to delegate any specific powers to any other officer, Director or agent of the Corporation and, to the extent required by applicable law, shall be considered to be the President of the Corporation. The Chairperson shall, on behalf of the Corporation, as authorized by the Board, execute all deeds, notes, bonds, mortgages, contracts and other instruments in writing.

Section 4. Executive Director. The Executive Director shall report to the Board of Directors. The Executive Director shall be the chief operating officer of the Corporation, and shall, subject to the direction of the Board of Directors, generally supervise, direct and control the business of the Corporation and shall have the responsibility for the day-to-day management of the business and affairs of the Corporation. The Executive Director shall attend meetings of the Board of Directors and shall make periodic reports to the Board of Directors and, as provided in Section 12 of Article IV, may require a vote of three-quarters (3/4) of the Directors for actions of the Board of Directors. The Executive Director shall appoint Regional Directors and other staff as necessary for the day-to-day operation of the Corporation. The Executive Director shall preside over the Annual General Meeting.

The Executive Director shall implement decisions of the Board of Directors and shall act, subject to the Board's authority and guidance, to enforce NAFA[®] policy, Rules of Racing and Corporate Policies and Procedures. The Executive Director may, subject to the Board's approval, delegate portions of these responsibilities to qualified individuals within NAFA[®]. The Executive Director may, from time to time, require special projects to be led or staffed. At the Executive Director's request, the Chairperson will appoint Special Project Leaders, teams and/or Committee members.

The Executive Director has the power to suspend or place on probation individuals or Clubs from all NAFA benefits and privileges for infraction of NAFA[®] Rules of Racing or Corporate Policies and Procedures subject to ratification by the Board of Directors at its next regular or annual meeting. This power is non-delegable.

Section 5. Vice-Chairperson. The Vice-Chairperson shall preside over meetings in the absence of the Chairperson and shall have such duties as may be given by the Board of Directors from time to time. The Vice Chairperson shall serve as the Co-chairperson of the Finance Committee.

Section 6. Secretary. The Secretary or, in the event of the Secretary's inability or refusal to act, a duly appointed Assistant Secretary shall attend all meetings of the Board of Directors, and shall record, or cause to be recorded, all the proceedings of the meetings of the Board of Directors in a book to be kept for that purpose, and shall archive reports or minutes provided by Committees. The Secretary shall give, or cause to be given, notice of all meetings of the Board of Directors, and shall perform such other duties as may be prescribed by the Board of Directors or the Executive Director. The Secretary shall maintain a current list of the Board of Directors detailing when each Director's term expires. The Secretary shall have custody of the corporate seal of the Corporation, and the Secretary, or an Assistant Secretary, shall have authority to affix the same to any instrument requiring it, and when so affixed it may be attested by the signature of the Secretary or by the signature of the Assistant Secretary. The Board of Directors may give general authority to any other officer to affix the seal of the Corporation and to attest the affixing by such officer's signature. The Secretary or an Assistant Secretary may also attest all instruments signed by the officers of the Corporation.

Section 7. Treasurer. Subject to the direction of the Board of Directors, the Treasurer shall have general oversight responsibility for the financial affairs of the Corporation. The Treasurer shall serve on the Finance Committee as its Co-chairperson, have custody of the corporate funds and securities of the Corporation, and shall keep a full and accurate accounting of the receipts and disbursements and books belonging to the Corporation. The Treasurer shall deposit all monies and all other valuable assets delivered to him to the credit of the Corporation in such depositories as may be designated by the Board of Directors or the Finance Committee. The Treasurer shall see that appropriate signatory cards are executed and maintained as current and shall bring all papers needed to accomplish this to the annual meeting of the Board of Directors. The Treasurer shall render to the Board of Directors at the Board's regular meetings, or when the Board of Directors so requires, but not less than quarterly, an account of the financial condition of the Corporation, to include but not be limited to income statements, comparative income statements, balance sheets, accounts receivable, and accounts payable and shall call on and make available to the outside accounting firm retained by the Finance Committee as provided in Article V, Section 2(b) of these Bylaws such materials as may be requested by the Board, the Finance Committee or the outside accounting firm.

The Treasurer shall perform such other duties and have such other powers as the Board of Directors may prescribe.

Section 8. Bond. The Corporation shall bond the Treasurer in such sum and with such surety as shall be satisfactory to the Board of Directors for the faithful performance of the duties of the Treasurer. If required by the Board of Directors, any other officer shall give the Corporation a bond in such sum and with such surety or sureties as shall be satisfactory to the Board of Directors for the faithful performance of the duties of that office and for the restoration to the Corporation, in case of their death, resignation, retirement or removal from office, of all books, papers, vouchers, money and other property of whatever kind, in their possession or under their control and belonging to the Corporation. Payment of the bond shall be by the Corporation.

Section 9. Authority for Expenditures. The Treasurer, the Executive Director, and the Chairpersons of the Board and the Finance Committee shall each have the authority, pursuant to his signature to approve and direct expenditures in accordance with the direction of the Board on behalf of and in the best interest of the Corporation. For expenditures in excess of \$5,000 the written approval of at least two of the above-named officers shall be required.

Section 10. Indemnification. The Corporation shall, to the greatest extent permitted from time to time by the laws of the State of Michigan, indemnify any person made, or threatened to be made, a party to an action, suit or proceeding (whether civil, criminal, administrative or investigative), whether such is an action by or in the right of the Corporation or otherwise, by reason of the fact that such person is or was a Director, officer, or member of a Committee of the Corporation or, while serving as a Director, officer or member of a Committee of the Corporation, serves or served any other enterprise at the request of the Corporation (all of such persons being sometimes referred to in this Article VI as a "Corporate Functionary"), against all expenses (including attorneys' fees), judgments, fines and amounts paid in settlement actually and reasonably incurred by such person in connection with such action, suit or proceeding. The Corporation may also, to the extent authorized from time to time by the Board of Directors, grant rights to indemnification to employees or agents of the Corporation and others to the fullest extent provided under the laws of the State of Michigan as they may be in effect from time to time.

Any indemnification under this Section shall be made by the Corporation only as authorized in the specific case upon a determination that indemnification of the Corporate Functionary or other person is proper in the circumstances because he has met the applicable standard of conduct. Such determination shall be made as provided by applicable law.

The rights of indemnification provided for in this Section shall be in addition to all rights to which any Corporate Functionary may be entitled under any agreement or as a matter of law or otherwise, and shall inure to the benefit of the Corporate Functionary's estate, heirs, executors and administrators. If this Section or any portion hereof shall be invalidated on any ground by a court of competent jurisdiction, the Corporation shall nevertheless indemnify each Corporate Functionary to the full extent permitted by any applicable portion of this Section that shall not have been invalidated.

The Corporation may purchase and maintain insurance on behalf of any Corporate Functionary against any liability asserted against him and incurred by him in any such capacity or arising out of his status as such, whether or not the Corporation would have the power to indemnify him against such liability under the provisions of this Section.

ARTICLE VII - AFFILIATE CLUBS AND DELEGATES

Section 1. Local Organizations. There shall be local organizations which shall consist of Affiliate Clubs abiding by the policies and procedures of the Corporation approved by the Board of Directors. Affiliate Clubs must register with the Corporation and pay such fee as shall be established by the Board of Directors from time to time. An Affiliate Club may field any number of teams it desires. Such teams are not required to be individually registered with NAFA[®]. Each Affiliate Club must register with NAFA[®] a single individual or corporation (the "Club Owner") as the sole authority to correspond with NAFA[®] on their behalf. The Corporation shall recognize changes in the identity of the Club Owner representing a particular Affiliate Club only if it receives a written direction from the former Club Owner or a court order.

Section 2. Delegate Vote Calculations. Delegate votes are calculated based on the activities of the Affiliate Club or service by an individual during the preceding Racing Year. At the end of the Racing Year,

NAFA[®] will notify the Club Owner of each Affiliate Club and each individual who provided service of the number of delegate votes earned that year. Delegate votes are determined as follows:

- (a) **Affiliate Club Delegate Votes.** An Affiliate Club must compete in at least one (1) event during the preceding Racing Year to qualify for delegate votes. An Affiliate Club earns delegate votes by competing in or hosting tournaments according to the follow schedule: one (1) delegate vote for 4-5 team entries; two (2) delegate votes for 6-11 team entries; three (3) delegate votes for 12-17 team entries; four (4) delegate votes for 18-23 team entries; five (5) delegate votes for 24-29 team entries; and six (6) delegate votes for 30 team entries or more. One (1) delegate vote per Affiliate Club will be awarded for hosting each tournament. No Affiliate Club shall earn more than eight (8) delegate votes in total by team entries or tournament hosting.
- (b) **Service Votes.** An individual who serves as a NAFA[®] Board member, Regional Director, or an approved or supervising judge shall receive one (1) delegate vote for each form of service rendered, up to a total of three (3) delegate votes, over and above any delegate votes otherwise earned.
- (c) **Distribution of Delegate Votes.** The Board of Directors may, from time to time, adopt and modify rules or guidelines to provide for individual delegate votes awarded to Affiliate Clubs to be issued directly to the delegates named by the Club Owner but, absent such rule or provision, NAFA[®] shall distribute all delegate votes awarded to an Affiliate Club to the Club Owner. When multiple votes are awarded to a Club Owner or single individual, they may be voted separately or as a block.

Section 3. Rules Governing Delegate Voting. Delegate voting for Directors and the Executive Director and on matters submitted to delegate vote by the Board of Directors shall be conducted by mail or by electronic transmission pursuant to policies and procedures approved from time to time by the Board of Directors. Such policies and procedures shall provide for notice to Club Owners of Affiliate Clubs and individuals of the number of delegate votes earned; and for validating and counting ballots either by the Election Committee or through such outside service as the Board may, in its discretion, retain for such purposes.

Section 4. Annual General Meeting. NAFA's Annual General Meeting shall be held within the period between December 1st and January 31st inclusive at such time and place as determined by the Board of Directors. Written notice of the Annual General Meeting shall be given by mail or electronic transmission to delegate vote holders and Directors of the Corporation at least thirty (30) days in advance of the meeting. The Executive Director shall preside at the Annual General Meeting. In the absence of the Executive Director, the Chairperson shall preside. At the Annual General Meeting, the results of the Board of Directors election and, when applicable, the results of the election for Executive Director, shall be announced.

Section 5. Delegate Action. The following shall be determined by delegate vote:

- (a) The election of the members of the Board of Directors and Executive Director, as provided in Article IV, section 4 of these Bylaws;
- (b) The election of dogs to the Hall of Fame or Regional MVP or such other recognition as may be provided for from time to time for dogs or individuals within NAFA[®];
- (c) Such proposed changes in the Rules of Racing, awards and other forms of recognition for performance in NAFA[®] racing events or service to the Corporation, and other matters affecting the conduct of events for approval as the Board may, in its discretion, choose to submit to either a binding or non-binding delegate vote. Binding approval by delegate vote of changes in the Rules of Racing shall require the affirmative vote of two-thirds (2/3) of the valid votes cast. The Board of Directors may, however, in its discretion approve changes in the Rules of Racing that have been approved by a majority, but less than two-thirds (2/3), of the valid delegate votes cast. A proposed change in the Rules of Racing that has been presented for a binding delegate vote and has not been approved by the delegates shall not be presented to the delegates again for at least three (3) years unless the Executive Director approves in writing.

ARTICLE VIII - GENERAL PROVISIONS

Section 1. Seal. The Board of Directors shall adopt a seal for the Corporation.

Section 2. Fiscal Year. The fiscal year of the Corporation shall commence on October 1 and end on September 30 of each year.

Section 3. Legal Construction. If any Bylaw provision is held to be invalid, illegal or unenforceable in any respect, the invalidity, illegality or unenforceability shall not affect any other provision and the Bylaws shall be construed as if the invalid, illegal or unenforceable provision had not been included in the Bylaws.

ARTICLE IX - AMENDMENTS TO BYLAWS

These Bylaws may be altered, changed, added to or amended at any regular or special meeting of the Board of Directors. Said alterations, changes, additions or amendments shall be passed upon by the vote of a majority of the members of the Board of Directors then in office.

The foregoing constitutes the Bylaws of the Corporation presented to and duly adopted by the Board of Directors on the __ day of _____, 20__.

Secretary,
Flyball

North American
Association, Inc.

NORTH AMERICAN FLYBALL ASSOCIATION, INC.®

APPENDIX A

Schedule of Fees

Competition Racing Numbers (CRN) - \$20.00 USD or \$22.00 CDN.

New NAFA® Club Registration - \$25.00 USD or \$28.00 CDN.

Height Card Applications - \$10.00 USD or \$11.00 CDN.

Duplicate Height Cards (due to loss) \$10.00 USD or \$11.00 CDN.

Replacement Award Pins (due to loss) \$5.00 USD or \$6.00 CDN.(excluding Hobbes Pins)
Hobbes Pins – current market value (contact Executive Director)

NAFA® Approved Patches \$5.00 USD or \$6.00 CDN.

Recording Fees (payable by the host Club):

- When tournaments are scored electronically and results and funds are received by NAFA within 14 days of the end of the tournaments:
 - \$20.00 USD per team that competes in a single day NAFA sanctioned tournament; or \$30.00 USD per team for tournaments lasting more than 1 day.
 - When multiple tournaments hosted by the same club occur on successive days and each is scored electronically, the full fee per team is due for the tournament with the largest entry and \$10.00 USD per team may be deducted from each additional tournament.
- When tournaments do not meet the above discount requirements (not scored electronically or received late):
 - \$25.00 USD per team that competes in a single day NAFA sanctioned tournament; or \$35.00 USD per team for tournaments lasting more than 1 day.
- Clubs submitting their fees in Canadian funds must report the exchange rate used on the NAFA Form C.6 from TD Canada Trust for purchasing US Dollars.

Late Schedule & Seeding Fee - \$50.00 USD when a host club fails to provide a preliminary schedule, tournament format and seeding to the Regional Director 10 days in advance of an event (payable by the Host Club).

NAFA® Tournament Results and Fees that arrive to NAFA® after 14 days have the following penalties;
15 plus days late, a fee of \$50.00 USD will be charged.
One calendar month plus, a \$100.00 USD late fee will be charged.
Disciplinary action will be taken for results received any later than two calendar months late.

Refer Charges for conduct prejudicial to the sport of Flyball - \$100.00 USD (refundable if charges are sustained).

Checks returned for Non-Sufficient Funds - \$25.00 USD. If a check received for a CRN is returned NSF, the team will not receive points because the dog does not have a valid CRN.

Copy of timesheet - \$5.00 USD or \$6.00 CDN per timesheet.

Failure to ship out NAFA® EJS:

Failure to ship out NAFA® EJS the next available day after the tournament - \$100.00 USD.

Failure to ship out NAFA® EJS the next day after the tournament and failure to do so affects the next tournament - \$250.00 USD.

For fees stated only in USD, payments in Canadian funds will be computed using the current exchange rates from TD Canada Trust to purchase US Dollars

NORTH AMERICAN FLYBALL ASSOCIATION, INC.®

APPENDIX B

NAFA® Forms

NAFA® Rules and Policies

C.1 Tournament Entry Form

Tournament _____ Fee _____

Host Club _____ Date _____

NAFA® Club # _____ Seed Time _____

Team Name _____ Class Reg Multi
Open Vets

Captain _____ Phone _____

Address _____

City _____ State/Prov _____ Zip/Postal Code _____

Email address: _____

Team Accomplishments:

1. Handler _____ Dog's Name _____
Breed _____ CRN# _____
Titles/Other _____ Jump Height _____

2. Handler _____ Dog's Name _____
Breed _____ CRN# _____
Titles/Other _____ Jump Height _____

3. Handler _____ Dog's Name _____
Breed _____ CRN# _____
Titles/Other _____ Jump Height _____

4. Handler _____ Dog's Name _____
Breed _____ CRN# _____
Titles/Other _____ Jump Height _____

5. Handler _____ Dog's Name _____
Breed _____ CRN# _____
Titles/Other _____ Jump Height _____

6. Handler _____ Dog's Name _____
Breed _____ CRN# _____
Titles/Other _____ Jump Height _____

Box Loader: _____

NAFA® Event# _____
 C.2 Time Sheet 3/5 Format

NAFA® Rules and Policies

B/O Time _____

Tournament _____ City, State/Prov. _____

Judge _____ Date _____

Team _____ NAFA® Club# _____ Seed Time _____

Captain _____ Phone# _____

	Dog	Breed	Jump Hgt	Handler/Owner	CRN #	(NAFA® use only)
1						
2						
3						
4						
5						
6						

Heat #	Opponent	Dog	Time	W	L	T
_____ of _____ vs _____	_____	1 2 3 4 5 6	_____	_____	_____	_____
_____ of _____ vs _____	_____	1 2 3 4 5 6	_____	_____	_____	_____
_____ of _____ vs _____	_____	1 2 3 4 5 6	_____	_____	_____	_____
_____ of _____ vs _____	_____	1 2 3 4 5 6	_____	_____	_____	_____
_____ of _____ vs _____	_____	1 2 3 4 5 6	_____	_____	_____	_____
<hr/>						
_____ of _____ vs _____	_____	1 2 3 4 5 6	_____	_____	_____	_____
_____ of _____ vs _____	_____	1 2 3 4 5 6	_____	_____	_____	_____
_____ of _____ vs _____	_____	1 2 3 4 5 6	_____	_____	_____	_____
_____ of _____ vs _____	_____	1 2 3 4 5 6	_____	_____	_____	_____
_____ of _____ vs _____	_____	1 2 3 4 5 6	_____	_____	_____	_____
<hr/>						
_____ of _____ vs _____	_____	1 2 3 4 5 6	_____	_____	_____	_____
_____ of _____ vs _____	_____	1 2 3 4 5 6	_____	_____	_____	_____
_____ of _____ vs _____	_____	1 2 3 4 5 6	_____	_____	_____	_____
_____ of _____ vs _____	_____	1 2 3 4 5 6	_____	_____	_____	_____
_____ of _____ vs _____	_____	1 2 3 4 5 6	_____	_____	_____	_____
<hr/>						
_____ of _____ vs _____	_____	1 2 3 4 5 6	_____	_____	_____	_____
_____ of _____ vs _____	_____	1 2 3 4 5 6	_____	_____	_____	_____
_____ of _____ vs _____	_____	1 2 3 4 5 6	_____	_____	_____	_____
_____ of _____ vs _____	_____	1 2 3 4 5 6	_____	_____	_____	_____
_____ of _____ vs _____	_____	1 2 3 4 5 6	_____	_____	_____	_____
<hr/>						
_____ of _____ vs _____	_____	1 2 3 4 5 6	_____	_____	_____	_____
_____ of _____ vs _____	_____	1 2 3 4 5 6	_____	_____	_____	_____
_____ of _____ vs _____	_____	1 2 3 4 5 6	_____	_____	_____	_____
_____ of _____ vs _____	_____	1 2 3 4 5 6	_____	_____	_____	_____
_____ of _____ vs _____	_____	1 2 3 4 5 6	_____	_____	_____	_____

Division: _____ Place: _____ Best Time: _____

NAFA® Rules and Policies

C.3 Application for a NAFA® Sanctioned Tournament

*=Required Field

Tournament Name (if any): _____

Wknd#: _____

*Site Name & street address: _____

*Venue City & State/Prov: _____ Zip/P.C.: _____

*Host Club(s): _____ *NAFA® Club#s: _____

*Start Date (MM/DD/YY): _____ *# Days: _____ *Closing Date: _____

*Entry Fees and Classes offered:

*Regular: \$ _____ /team US CAN Unlimited Limited to _____ teams

Multibreed: \$ _____ /team US CAN Unlimited Limited to _____ teams

Veterans: \$ _____ /team US CAN Unlimited Limited to _____ teams

Open: \$ _____ /team US CAN Unlimited Limited to _____ teams

Other _____ : \$ _____ /team US CAN Unlimited Limited to _____ teams

Head Judge: _____ Judge 2 (if needed): _____

*Tournament Director

*Entries Chairperson (if different)

Name _____

Name _____

Phone _____

Phone _____

Mailing Address _____

Mailing Address _____

E-mail address _____

E-mail address _____

*Do you want NAFA's Electronic Judging System? Yes No # Requested _____

*EJS Ship To: Name _____ Address _____

*Phone #: _____

E-mail address _____

*Running Surface: _____ *Minimum Racing Lane Run-Back: _____ FT

*Tournament site governed by Breed Specific Legislation: Yes No If yes, please specify.

*Special Rules, Requests, or comments:

For NAFA® Use Approval Date: _____

Event #: _____

Reserve

NAFA® Rules and Policies

C.4 Tournament Checklist

- Select Tournament Committee
 - Tournament Chairperson
 - Entries Chairperson
 - Grounds
 - Equipment
 - Trophy Chairperson
 - Hospitality Chairperson
 - Photographer
 - Judges
 - Publicity
 - Admission
 - Public Address
 - Catalog Chairperson
 - Raffle
 - Special Events
-
- Set entry fee
 - Select and secure site
 - Set date, time and place
 - Determine number of races that can be held in time allowed
 - Determine tournament format
 - Determine schedule
 - Determine number of entries
 - Set the closing date
 - Determine prizes
 - Assemble judging panel
 - Submit application to NAFA®
 - Contact printer for flyers, forms, catalog
 - Mail out flyers
 - Reserve hotel rooms, banquet rooms...
 - Order trophies and ribbons
 - Notify press of the date, time, location and what Flyball involves
 - Secure volunteers for:
 - Set Up
 - Admission
 - Cleanup
 - Parking
 - Raffle
 - Hospitality
 - Make arrangements for:
 - Mats
 - Gating
 - Jumps
 - Display Board
 - Whistles
 - Flags
 - Clip Board
 - Stop Watches
 - 50 - 100 Foot Tape
 - Rulers
 - Signage
 - Tables/Chairs
- Record entries as they arrive
- Obtain certificate of additional insured and provide to NAFA® at least 15 days prior to tournament
- Finalize schedule
- Review schedule and seeding with your Regional Director
- Mail entry package to clubs and Judges. Package should include the following:
 - Maps of where to stay, where to eat and local points of interest
 - Final schedule and seeding
- Finalize banquet and hotel arrangements
- Finalize arrangements for a Veterinarian
- Pay Judges
- Pick up and deliver equipment, trophies, ribbons
- Set up ring(s), tables, post signage, gating,...
- HOLD THE TOURNAMENT!!!**
- Tabulate results and award prizes in a formal award ceremony
- Clean up the show site
- Within 14 days, submit full records and tournament recording fee to NAFA®

NAFA Rules and Policies

C.5 Judge's Application

Name: _____ Phone: _____

Address: _____ Fax: _____

City _____ State/Province _____ Zip/Postal _____

E-mail Address: _____

Please provide a brief description of your qualifications:

By signing below, I certify that I meet the initial requirements to begin the training program as set forth in the NAFA® Judges Training Program.

Signature: _____ Date: _____

(/s/ followed by a typed signature can be used for electronic submission)

NAFA® Rules and Policies

Event # _____

Event # _____

Event # _____

C.6 Tournament Results Form

Tournament: _____

Date: _____

Host Club: _____

Host Club #: _____

Region: (Host Club's Regional Affiliation as of Start of Racing Year): _____

Tournament Director: _____

Phone: _____

Address: _____

E-Mail: _____

City, State/Province: _____

Zip/Postal Code: _____

Along with this form, the following items must be completed and sent to NAFA® within 14 days after the tournament, via NAFA® approved courier (late fees apply after 14 days).

- The division's judge must sign each time sheet (Form C.2). Please note the judge's name, if not legible.
- Bottom of each time sheet (Form C.2) must be completed with division number, best time and placement
- When results are set electronically:
 - o **The Host Club must retain C.2 timesheets for one year after the tournament.**
- When results are not sent electronically:
 - o C.2 timesheets must be sent to NAFA
- Jump Height Form(s) (Form C.9)
- If applicable, include any statements with respect to conduct prejudicial to the sport of NAFA Flyball.
- If applicable, include any protest(s).
- If applicable include Fom C.15 Judges Reort Form
- EJS Shipping Cost (attach receipt). Specify payment in USD or CDN funds. ***NOTE: No deductions from a Tournament Fee shall be made without the prior approval of the Executive Director.**

NAFA® recording fee @ \$25 USD per scored team for single day tournaments and \$35 USD for tournaments lasting more than 1 day. Fee is reduced to \$20/\$30 USD per team (single day/multi day) if the host club submits scored tournament results electronically. When multiple tournaments hosted by the same club occur on successive days, **and each is scored electronically**, the full fee is due for the tournament with the largest entry and \$10.00 USD per team may be deducted from each additional tournament.

Event #	# Of Scored Teams	Recording Fee (see above notes)	Total Due Per Event (Entries x Fee)
Largest Entry Event #		\$35/\$30/\$25/\$20	
2 nd Largest Entry Event #		\$35/\$25/\$20/\$10	
3 rd Largest Entry Event #		\$35/\$25/\$20/\$10	
Fees Remitted			
\$	Total Recording Fee(s) due to NAFA from all Events as calculated above		
\$	Late Fees (if applicable)		
\$	Less EJS Shipping Cost (attach receipt): USD or CDN (circle one)*		
\$	Total Remitted to NAFA		

Attach check or Money Order – US or Canadian Funds (US to CDN exchange rate used _____)

Forward to: North American Flyball Association, Inc. ®
 PO Box 69
 Westfield, IN 46074

NAFA® Rules and Policies

C.8 Application for a NAFA® Competition Registration # (CRN)

Dogs Name (Call Name): _____ Breed: _____
Owner's Name: _____ Phone#: _____
Address: _____
City: _____ State/Prov: _____ Zip/Postal Code: _____
Dog's Birth Date: _____
E-Mail Address: _____
Name of Dog as you would like it to appear on Awards: _____
Club Number: _____ Club Name: _____

Dogs Name (Call Name): _____ Breed: _____
Owner's Name: _____ Phone#: _____
Address: _____
City: _____ State/Prov: _____ Zip/Postal Code: _____
Dog's Birth Date: _____
E-Mail Address: _____
Name of Dog as you would like it to appear on Awards: _____
Club Number: _____ Club Name: _____

Dogs Name (Call Name): _____ Breed: _____
Owner's Name: _____ Phone#: _____
Address: _____
City: _____ State/Prov: _____ Zip/Postal Code: _____
Dog's Birth Date: _____
E-Mail Address: _____
Name of Dog as you would like it to appear on Awards: _____
Club Number: _____ Club Name: _____

***Check or money order for \$20 US or CDN funds made payable to NAFA® Inc. must be enclosed.
To: NAFA® Inc. 1333 W Devon Avenue #512, Chicago, IL 60660
Please allow 4-6 weeks for processing.***

**Raised NAFA® Seal
must appear here**

Dogs must race in NAFA® sanctioned events for 1 year before applying for a height card application.

C.10 Height Card Application

Dogs NAFA®Reg. Name: _____ Gender: Female Male
CRN#: _____ Date of Birth: _____
Breed of Dog: _____
Owner: _____ Phone: _____
Address: _____
City: _____ State/Prov: _____ Zip/Postal Code: _____

Email address: _____
MEASUREMENTS

Date of Tournament: _____ Measurement of dog at withers: _____
Host Club: _____
Judges Name (Print): _____ Judge's Signature: _____
Supervising Head Judge Yes No

Date of Tournament: _____ Measurement of dog at withers: _____
Host Club: _____
Judges Name (Print): _____ Judge's Signature: _____
Supervising Head Judge Yes No

Date of Tournament: _____ Measurement of dog at withers: _____
Host Club: _____
Judges Name (Print): _____ Judge's Signature: _____
Supervising Head Judge Yes No

Date of Tournament: _____ Measurement of dog at withers: _____
Host Club: _____
Judges Name (Print): _____ Judge's Signature: _____
Supervising Head Judge Yes No

Date of Tournament: _____ Measurement of dog at withers: _____
Host Club: _____
Judges Name (Print): _____ Judge's Signature: _____
Supervising Head Judge Yes No

This form is complete when it contains three (3) matching measurements, at least one (1) of which is from a supervising judge.

Application must be presented to the measuring judge before the dog is measured

Dogs must race in NAFA® sanctioned events for 1 year before applying for a height card application.

C.10A Height Card Application – use this form to apply for Height Card

Dogs NAFA® Reg Name: _____ Gender: Female Male

CRN#: _____ Date of Birth: _____

Breed of Dog: _____

Owner: _____ Phone: _____

Address: _____

City: _____ State/Prov: _____ Zip/Postal Code: _____

Email: _____

Please mail completed form with required fee to: **NAFA® Inc., 1333 W. Devon Ave. #512, Chicago, IL 60660** - Allow 2-4 weeks for processing.

NAFA® Rules & Policies

C.11 New Club Registration Form

Requested Club Name _____

Club Owner (Must name single individual or Corporation as sole authority with NAFA®) _____

Team Captain _____

Address _____

City _____ State _____

Zip/Postal Code _____ Phone No. _____

E-mail Address _____

Team Contact - if different _____

Address _____

City _____ State _____

Zip/Postal Code _____ Phone No. _____

E-mail Address _____

Please list any CRN Numbers that need to be transferred to this new team

CRN#	Dog's Name	Owner's Name

Use NAFA® Form C.8 when requesting any new CRN numbers.

Mail completed form with \$25 U.S. or CDN Funds to: NAFA®, Inc. 1333 W. Devon Avenue #512 Chicago, IL 60660

Please allow 2-4 weeks for processing.

NAFA® Rules and Policies

C.12 Notice of Excusal

Tournament: _____ Date: _____

Judge: _____ Tournament Director: _____

Reason for Excuse: Lame _____ In Heat _____ Aggression _____ Other _____

Dog's Name: _____ CRN# _____

Team Name: _____

Aggression Details

Time of Violation: _____ Race Number _____ vs. _____

Injuries Sustained: _____

Evidence: _____

Did the dog require Veterinary attention? Yes _____ No _____

Eyewitness Reports: _____

Eyewitness Reports: _____

Judge's Findings: _____

Judges Signature: _____ Date: _____

Owner's/Handler's signature: _____ Date: _____

Owner's/Handler's
Address: _____ email: _____ phone: _____

NAFA Judge must mail the original, or scan and email the completed form to the NAFA® address within 10 days for distribution to the Review Panel. Copies to: Judge, Regional Director, and Owner/Handler.

NAFA® Rules and Policies

C.13 NAFA® World Record Report Form

1. On the day of the event, questions regarding this procedure should be directed to the Regional Director.
2. Racing should be stopped immediately after a record has been achieved and not resumed again until the required information has been completed in blue or black ink on this form.

Date: _____ Race and Ring Number: _____
 Running Surface: _____ Head Judge: _____
 Regional Director: _____ Tournament Director: _____
 Event Number: _____
 Host Club Name & Number: _____
 City, State (Province): _____

Record setting team information (To be completed by the Head Judge)

Record time: _____ Class of competition (circle one): regular / multibreed

Team name & number: _____ Team Captain: _____

Line-up:

	Dog	Breed	Jump Hgt	Handler/Owner	CRN
1					
2					
3					
4					

Box loader: _____

Check list of action to take place to verify the record (see section 6.2 - Record Times in NAFA® Rules of Racing)

1. The Head Judge will do the following:

- A. Measure the course to verify that it is set properly. This includes:
 - Racing lane length
 - Jump placement
 - Jump height
 - EJS is aligned correctly on the Start/Finish line
- B. Verify the height dog measurement
- C. Check the box. This includes:
 - Throw of all sizes of balls used from all holes
 - Placement

I, as Head Judge, verify that the racing lane, jump height and placement, height of the jump height dog, the flyball box and balls have all met NAFA® regulations:

Head Judge: _____ Date: _____

2. The video must be reviewed by two neutral members of the Board of Directors and meet the following requirements:

- A. To be a world record, a video of the heat is mandatory.
- B. The video must include the following:
 - Start finish line.
 - Sensor panels
 - Light tree
- C. All passes / exchanges must be clean to qualify for a world record
- D. The electronic judging system must not show any errors or faults
- E. All dogs must carry a ball over the finish line
- F. The heat should be timed with a stopwatch when the video is reviewed.

We, as neutral members of the NAFA® Board of Directors, do hereby certify that we have reviewed the video and that all passes / exchanges are clean and that the electronic judging system showed no errors or faults. We do hereby declare a new official NAFA® World Record.

Reviewed by: _____ Date: _____

Reviewed by: _____ Date: _____

3. If there are not two neutral members of the Board of Directors available at the tournament:

- A. The original or a copy of the video will be forwarded to the Executive Director to coordinate the review process.
- B. The Executive Director must receive the original or a copy of the video within fourteen days.

NAFA® Rules and Policies

C.13 NAFA® World Record Report Form Instructions

What to do when a possible world record has been achieved:

1. Racing should be stopped immediately.
2. The Head Judge should notify the Regional Director of the possible world record. At that time if they have any questions on how to proceed, or during the time of recording the information and verification, they should be directed to the Regional Director.
3. The world record form should be pulled from the rules of racing and the general information at the top should be filled out in prior to proceeding to the checklist portion.

Checklist portion:

1. Course, height dog, box verification and ball:
 - A. Measuring the course:
 1. If you need assistance to do the measuring it is recommended that you have the Regional Director or Tournament Director help.
 2. All measurements must meet NAFA® measurement tolerances using a single, continuous tape.
 3. All jumps should be measured for height and be within 1/4".
 4. Jump placement must be within 2" of the jump-set line.
 - B. Verify the height dog measurement:
 1. Refer to the height dog measurement sheet.
 - a. If the dog has a height card, which can be presented to the judge for verification, no action is necessary.
 - b. If the dog was measured prior to racing, no action is necessary.
 - c. If the dog was not measured prior to racing, it is mandatory that it be measured at this time.
 - C. Check the flyball box:
 1. Dimensions must meet NAFA® standards. It must be measured at this time, unless it was previously measured at the tournament.
 2. Throw of all holes using all sizes of balls used must be checked.
 3. The placement of the box should be at least 51' from the start finish line.

If all of the above requirements are met, the Head Judge should sign and date the world record form. It should be given to the team captain so that they can submit it along with a copy of the video to the Board of Directors.

2. Video tape verification:
 - A. To be considered for a world record an unedited videotape is mandatory.
 - B. The video must be stationary and in line with the start finish line, with a clear view of the sensor panels, and the light tree.
 - C. All passes / exchanges must be clean to qualify for a world record.
 - D. The electronic judging system must not show any errors or faults.
 - E. All dogs must carry their ball over the finish line.
 - F. The heat should be timed with a stopwatch when the video is reviewed. The hand timing is to confirm that the tape is of the actual run in question.

*Special notes

- If two neutral members of the Board of Directors are present at the tournament, the video may be reviewed at that time.
- It may be necessary to view the tape at a later time due to poor tape or lighting quality and or the size of the screen available to view the tape on.
- The run in question must meet all of the above criteria or it cannot be considered for world record status.

If all of the above requirements are met, both members of the Board of Directors should sign and date the world record form. A copy of the world record form must be submitted to the Executive Director within fourteen days in order to record the new record.

3. If there are not two neutral members of the Board of Directors available at the tournament:
 - A. The original or a copy of the video will be forwarded to the Executive Director to coordinate the review process.
 - B. The Executive Director must receive the original or a copy of the video within fourteen days of the run in question.
 - C. A completed copy of the world record form must accompany the tape.
 - D. All of the criteria in item 2 must still be met.

All records will be confirmed by NAFA® within 14 days of receipt of the necessary documents.

NAFA® Rules and Policies

C.14 Number Not Used – Hold for Future Use

NAFA® Rules and Policies

C.15 Judge's Report Form

Host Club: _____

Tournament Director: _____

Tournament Date: _____

Regional Director: _____

Judges Name: _____

Please indicate how you felt about the judge:

Was the judge punctual? _____

Did the judge have a good knowledge of the rules of racing? _____

Was the judge friendly and courteous? _____

Did the judge show confidence in the ring? _____

Did the judge keep a good pace? _____

Did the judge leave the teams and the spectators with the feeling that all teams were given an equal opportunity and no team was given an unfair advantage? _____

Comments: _____

This is an optional form that NAFA® encourages tournament directors to fill out and mail in with their tournament results.

NAFA® Rules and Policies

C.16 NAFA® Novice Review Form

Novice Judge Information

Name: _____ Address: _____
City: _____ State/Prov: _____ Zip/PC: _____
Home Phone: _____ Work Phone: _____ Cell Phone: _____
E-mail address: _____

Box Judging (may be completed under supervising or approved judge):

Date: _____ Sponsoring Team: _____
Location: _____ Supervising Judge (print): _____

Comments on Performance of Duties (to be completed by the supervising judge)

Performance was satisfactory to complete assignment: Yes _____ No _____

Judge's Signature: _____

Line Judging (may be completed under supervising or approved judge):

Date: _____ Sponsoring Team: _____
Location: _____ Supervising Judge (print): _____

Comments on Performance of Duties (to be completed by the supervising judge)

Performance was satisfactory to complete assignment: Yes _____ No _____

Judge's Signature: _____

Observational Assignment:

Date: _____ Sponsoring Team: _____
Location: _____ Supervising Judge (print): _____

Comments on Performance of Duties (to be completed by the supervising judge)

Performance was satisfactory to complete assignment: Yes _____ No _____

Supervising Judge's Signature: _____

Table Assignment (may be completed under supervising or approved judge):

Date: _____ Sponsoring Team: _____

Location: _____ Supervising Judge (print): _____

Comments on Performance of Duties (to be completed by the supervising judge)

Performance was satisfactory to complete assignment: Yes _____ No _____

Judge's Signature: _____

Measuring Training (assignment 1 - may be completed under supervising or approved judge):

Date: _____ Sponsoring Team: _____

Location: _____ Supervising Judge (print): _____

Comments on Performance of Duties (to be completed by the supervising judge)

Performance was satisfactory to complete assignment: Yes _____ No _____

Supervising Judge's Signature: _____

Measuring Training (assignment 2 - may be completed under supervising or approved judge):

Date: _____ Sponsoring Team: _____

Location: _____ Supervising Judge (print): _____

Comments on Performance of Duties (to be completed by the supervising judge)

Performance was satisfactory to complete assignment: Yes _____ No _____

Supervising Judge's Signature: _____

Measuring Training (assignment 3 – must be completed with supervising judge):

Date: _____ Sponsoring Team: _____

Location: _____ Supervising Judge (print): _____

Comments on Performance of Duties (to be completed by the supervising judge)

Performance was satisfactory to complete assignment: Yes _____ No _____

Supervising Judge's Signature: _____

NAFA® Rules and Policies

C.17 NAFA® Apprentice Judge Review Form (To Be Completed by Supervising Judge) Apprentice Judge Information

Name: _____ Address: _____
City: _____ State/Prov: _____ Zip/PC: _____
Home Phone: _____ Work Phone: _____ Cell phone: _____
E-mail address: _____

Supervising Judge:

Note: Must be on NAFA® list of approved Supervising Judges

Tournament Information

Date: _____ Sponsoring Team: _____
Location: _____ Tournament Director: _____

Tournament Director Information

Address: _____
City: _____ State/Prov: _____ Zip/PC: _____
Phone: _____
E-mail address: _____

Number of Races Judged (minimum 25) _____

Judging Start Time: _____ Judging End Time: _____
Manual Start : _____ EJS Start: _____

Please rate the Apprentice Judge on the following rate scale of 1 to 5 with 1 rating poor and 5 rating excellent.

Appearance	1	2	3	4	5
Knowledge of NAFA® Rules & Policies	1	2	3	4	5
Control of Ring	1	2	3	4	5
Attitude to Exhibitors & Officials	1	2	3	4	5
Measuring Dogs	1	2	3	4	5
Style	1	2	3	4	5

Comments: _____

Areas for Improvement: _____

Recommendations: Satisfactory Completion of Assignment
 Do Not Recommend

Please note:

Only applications with completed information will be reviewed. Your application will be reviewed by the NAFA® Board of Directors at the first in-person meeting after its receipt. You will be contacted by the Head of the NAFA® Judging Committee of the Board's decision within 10 days following the meeting.

This form should be returned to the Apprentice Judge when completed and when three approvals have been collected, the Apprentice should mail to: **NAFA® Judges & Guidelines Committee, 1333 West Devon Ave., Suite 512, Chicago, IL 60660**

NAFA® Rules and Policies

C.18 NAFA® Provisional Judge Review Form (To Be Completed by Tournament Director & Regional Director) Provisional Judge Information

Name: _____ Address: _____
City: _____ State/Prov: _____ Zip/PC: _____
Home Phone: _____ Work Phone: _____ Cell phone: _____
E-mail address: _____

Tournament Information

Date: _____ Sponsoring Team: _____
Location: _____ Tournament Director: _____

Tournament Director Information / Regional Director Information (please circle which one)

Name (TD or RD): _____
Address: _____
City: _____ State/Prov: _____ Zip/PC: _____
Phone: _____
E-mail address: _____

Number of Races Judged:

Judging Start Time: _____ Judging End Time: _____
Manual Start : _____ EJS Start: _____

Please rate the Provisional Judge on the following rate scale of 1 to 5 with 1 rating poor and 5 rating excellent.

Appearance	1	2	3	4	5
Knowledge of NAFA® Rules & Policies	1	2	3	4	5
Control of Ring	1	2	3	4	5
Attitude to Exhibitors & Officials	1	2	3	4	5
Measuring Dogs	1	2	3	4	5
Style	1	2	3	4	5

Additional Comments: _____

Areas for Improvement: _____

Recommendations: Satisfactory Completion of Assignment
 Do Not Recommend

Please note:

Only applications with completed information will be reviewed. Your application will be reviewed by the NAFA® Board of Directors at the first in-person meeting after its receipt. You will be contacted by the Head of the NAFA® Judging Committee of the Board's decision within 10 days following the meeting.

Provisional Judges should be given back this form, and when three approvals are collected, mail to:
NAFA® Judges & Guidelines Committee, 1333 West Devon Ave., Suite 512, Chicago, IL 60660

NAFA® Rules and Policies

C. 19 Application for NAFA® Supervising Head Judge

Date of application: _____ Date received by
NAFA®: _____

Applicant Information:
Name: _____ Address: _____
City: _____ State/Prov: _____ Zip/PC: _____
Home Phone: _____ Work Phone: _____ Cell phone: _____
E-mail address: _____ Applicant's home region: _____
Applicant's signature: _____

1. Amount of time applicant has been:

- a. Involved in the sport of flyball: _____
- b. As a NAFA® Approved Judge: _____

2. Please list the following information on a separate document:

- a. A minimum of 25 tournaments that you have judged, on separate weekends, since being an Approved Judge. Please include the date, host team, Tournament Director, Regional Director, city, state, and amount of judging completed for each event. It is also important that you indicate at which of these tournaments you measured dogs.
- b. Any disciplinary, probation or suspension actions that you have been involved in while participating in flyball either as a competitor or Judge.

3. Please attach original copies of the following documents:

- a. Signed letter of endorsement from your home region Regional Director.
- b. Signed letter of endorsement from your 5 Tournament Directors for which you judged as an Approved Judge.
- c. Signed letter of endorsement from 2 NAFA® Approved Judges with whom you have judged.

My goals should I be approved as a NAFA® Supervising Head Judge are as follows:

Please submit your application to:

NAFA®, Head of Judging Committee
1333 W. Devon Ave., Suite 512
Chicago, Il 60660

Please note:

Only applications with completed information will be reviewed. Your application will be reviewed by the NAFA® Board of Directors at the first in-person meeting after its receipt. You will be contacted by the Head of the NAFA® Judging Committee of the Board's decision within 10 days following the meeting.

NAFA® Use only

Presiding Head of Judging Committee: _____
Date: _____ Approved: _____ Rejected: _____

NAFA® Rules and Policies

C.20 Height Card Challenge Form

Challenged Dog

Dog's Name: _____ CRN: _____

Challenger:

Check One: NAFA® Club Owner NAFA® Judge

Name: _____ Club Name: _____

Witnessed Dog Run (MM/DD/YY): _____ NAFA® Event #: _____

Signature _____ Date _____

Mail to the Executive Director, NAFA®, 1333 Devon Ave, Suite 512, Chicago, IL 60660 within 14 days of tournament

Below for NAFA® Use Only

Date Received: _____ Fee Included: Y N Challenge Allowed: Y N

Dog Owner & Challenger Notified of Height Card Challenge on: _____

First 90 Days to Submit Acceptable Video Ends: _____

90 Day Period to Resubmit Acceptable Video Extended: Y N

Final Deadline to Submit Acceptable Video: _____

Challenged Dog's Owner: _____ Challenger Name: _____

Email: _____ Email: _____

Phone: _____ Phone: _____

Final Findings: No Acceptable Video Received Height Card Revoked Acceptable, Height Card Upheld

Acceptable, Height Card Revoked

Final Notifications: ED Notified Dog Owner _____ ED Notified Challenger _____

NAFA® Rules and Policies

C.21 Height Card Challenge—Judges' Committee Review Form

Challenged Dog

Dog's Name: _____ CRN: _____

Ad Hoc Committee (must be NAFA® approved judges)

Selected by Executive Director: _____ Date: _____

Selected by Judge's Committee: _____ Date: _____

Selected by Committee (first 2): _____ Date: _____

Date Video Received by ED: _____ Date Sent to Committee: _____ Date Reviewed by Committee: _____

Findings: Yes No

- Video is acceptable to show stand.
- Video has acceptable audio.
- Video shows stand conforming to NAFA® rules.

If Video Acceptable: Recommend Height Card Upheld Recommend Height Card Revocation

Date ED Notified by Committee: _____

Date ED Notified Dog Owner: _____ Date ED Notified Challenger If Acceptable Finding: _____

If Video Unacceptable, 90 days after ED Notified Dog Owner is _____ (acceptable video must be received by this date)

Findings: Yes No

- Video is acceptable to show stand.
- Video has acceptable audio.
- Video shows stand conforming to NAFA® rules.

If Video Acceptable: Recommend Height Card Upheld Recommend Height Card Revocation

Date ED Notified by Committee: _____

Date ED Notified Dog Owner: _____ Date ED Notified Challenger If Acceptable Finding: _____

Findings: Yes No

- Video is acceptable to show stand.
- Video has acceptable audio.
- Video shows stand conforming to NAFA® rules.

If Video Acceptable: Recommend Height Card Upheld Recommend Height Card Revocation

Date ED Notified by Committee: _____

Date ED Notified Dog Owner: _____ Date ED Notified Challenger If Acceptable Finding: _____

Findings: Yes No

- Video is acceptable to show stand.
- Video has acceptable audio.
- Video shows stand conforming to NAFA® rules.

Date ED Notified by Committee: _____

Date ED Notified Dog Owner: _____ Date ED Notified Challenger If Acceptable Finding: _____

NORTH AMERICAN FLYBALL ASSOCIATION, INC.®

APPENDIX C

Racing Schedules

3 TEAM ROUND ROBIN

RACE 1	3	vs	1
RACE 2	2	vs	3
RACE 3	1	vs	2

ALLOW 30 MINUTES FOR RACES

4 TEAM ROUND ROBIN

RACE 1	4	vs	1
RACE 2	2	vs	3
RACE 3	1	vs	3
RACE 4	4	vs	2
RACE 5	3	vs	4
RACE 6	1	vs	2

ALLOW 1 HOUR FOR RACES

5 TEAM ROUND ROBIN

RACE 1	5	vs	2
RACE 2	4	vs	1
RACE 3	3	vs	5
RACE 4	2	vs	4
RACE 5	1	vs	3
RACE 6	4	vs	5
RACE 7	2	vs	3
RACE 8	5	vs	1
RACE 9	3	vs	4
RACE 10	1	vs	2

ALLOW 1 HOUR & 20 MINUTES FOR RACES

6 TEAM ROUND ROBIN

RACE 1	2	vs	3
RACE 2	6	vs	1
RACE 3	4	vs	5
RACE 4	3	vs	6
RACE 5	4	vs	2
RACE 6	5	vs	1
RACE 7	2	vs	6
RACE 8	1	vs	4
RACE 9	5	vs	3
RACE 10	6	vs	4
RACE 11	2	vs	5
RACE 12	3	vs	1
RACE 13	5	vs	6
RACE 14	4	vs	3
RACE 15	1	vs	2

ALLOW 2 HOURS & 10 MINUTES FOR RACES

7 TEAM ROUND ROBIN

RACE 1	1	vs	4
RACE 2	2	vs	5
RACE 3	3	vs	6
RACE 4	4	vs	7
RACE 5	5	vs	1
RACE 6	6	vs	2
RACE 7	7	vs	3
RACE 8	1	vs	3
RACE 9	5	vs	7
RACE 10	2	vs	4
RACE 11	6	vs	1
RACE 12	3	vs	5
RACE 13	7	vs	2
RACE 14	4	vs	6
RACE 15	7	vs	1
RACE 16	2	vs	3
RACE 17	4	vs	5
RACE 18	6	vs	7
RACE 19	3	vs	4
RACE 20	5	vs	6
RACE 21	1	vs	2

ALLOW 3 HOURS FOR RACES

8 TEAM ROUND ROBIN

RACE 1	4	vs	8
RACE 2	3	vs	7
RACE 3	2	vs	6
RACE 4	1	vs	5
RACE 5	6	vs	1
RACE 6	8	vs	3
RACE 7	2	vs	5
RACE 8	4	vs	7
RACE 9	3	vs	6
RACE 10	5	vs	8
RACE 11	7	vs	2
RACE 12	1	vs	4
RACE 13	8	vs	2
RACE 14	4	vs	6
RACE 15	7	vs	1
RACE 16	3	vs	5
RACE 17	6	vs	8
RACE 18	2	vs	4
RACE 19	5	vs	7
RACE 20	1	vs	3
RACE 21	8	vs	1
RACE 22	6	vs	7
RACE 23	4	vs	5
RACE 24	2	vs	3

RACE 25	7	vs	8
RACE 26	5	vs	6
RACE 27	3	vs	4
RACE 28	1	vs	2

ALLOW 4 HOURS FOR RACES

9 TEAM ROUND ROBIN

RACE 1	1	vs	9
RACE 2	7	vs	5
RACE 3	8	vs	4
RACE 4	6	vs	3
RACE 5	9	vs	7
RACE 6	2	vs	8
RACE 7	5	vs	3
RACE 8	1	vs	6
RACE 9	4	vs	2
RACE 10	9	vs	5
RACE 11	8	vs	6
RACE 12	1	vs	7
RACE 13	3	vs	2
RACE 14	5	vs	4
RACE 15	1	vs	8
RACE 16	7	vs	6
RACE 17	2	vs	9
RACE 18	4	vs	3
RACE 19	2	vs	7
RACE 20	5	vs	1
RACE 21	3	vs	9
RACE 22	6	vs	4
RACE 23	9	vs	8
RACE 24	7	vs	3

RACE 25	4	vs	1
RACE 26	6	vs	2
RACE 27	8	vs	5
RACE 28	9	vs	6
RACE 29	7	vs	4
RACE 30	5	vs	2
RACE 31	3	vs	1
RACE 32	4	vs	9
RACE 33	8	vs	7
RACE 34	6	vs	5
RACE 35	3	vs	8
RACE 36	2	vs	1

ALLOW 5 HOURS & 10 MINUTES FOR RACES

3 TEAM DOUBLE ELIMINATION

Allow 40 Minutes For Racing
Team On Top On The Left

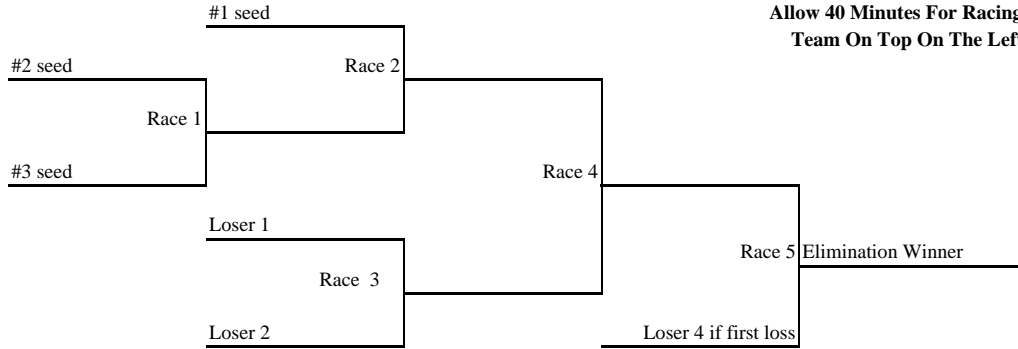

4 TEAM DOUBLE ELIMINATION

Allow 50 Minutes For Racing
Team on Top On The Left

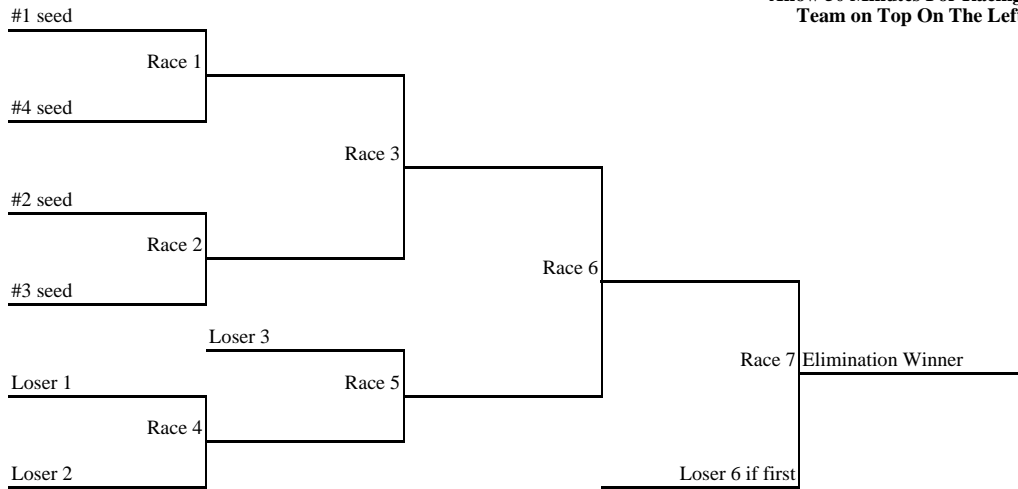

5 TEAM DOUBLE ELIMINATION

Allow 1 Hour And 10 Minutes

Team On Top On The Left

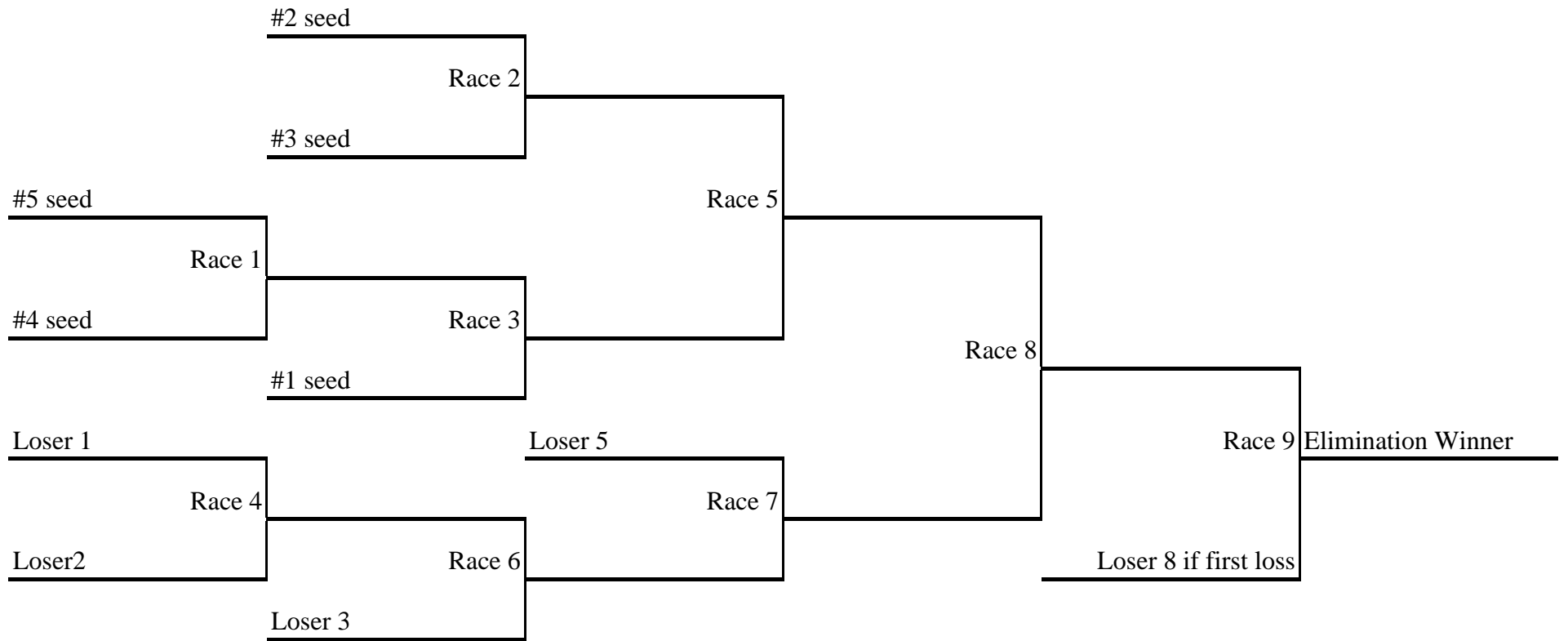

6 TEAM DOUBLE ELIMINATION

Allow 1 Hour And 30 Minutes For Racing

Team On Top On The Left

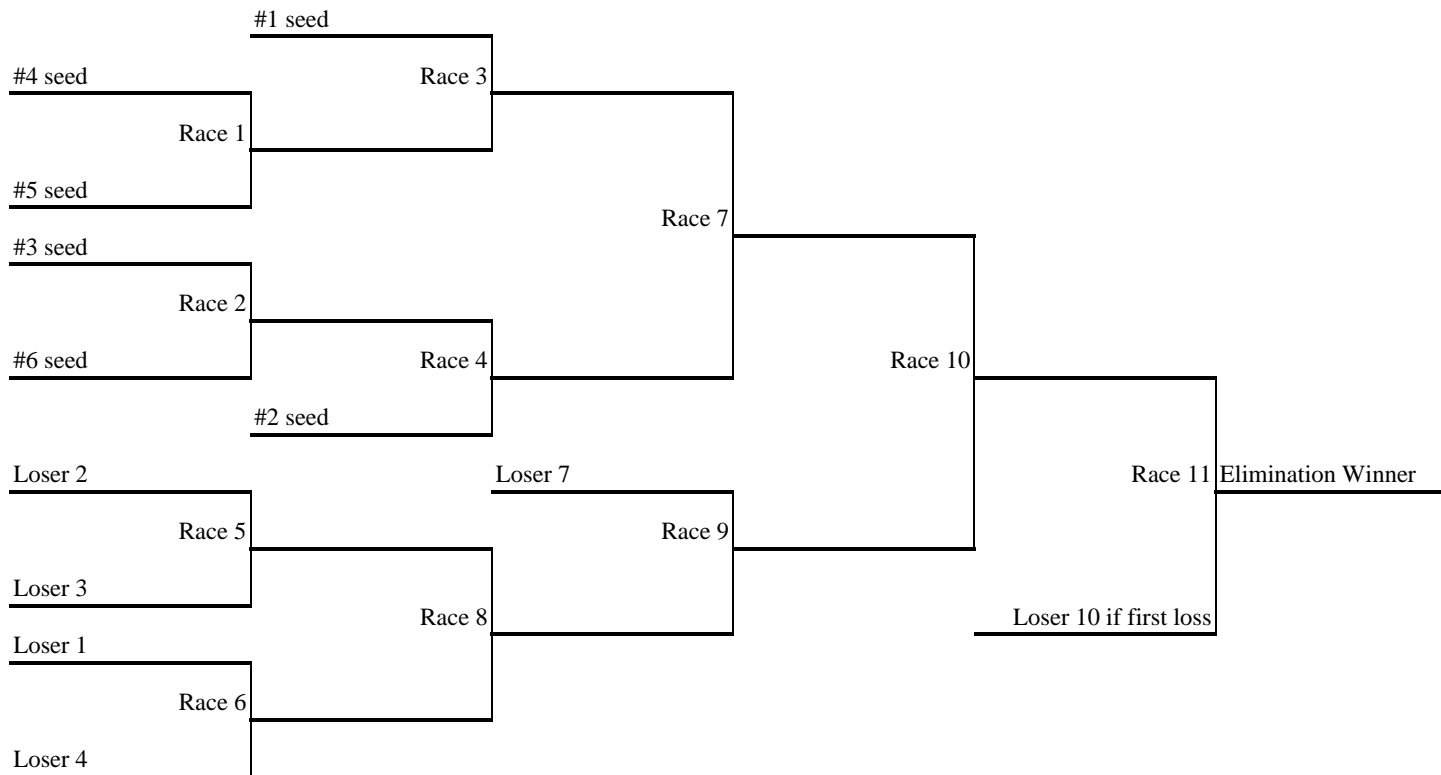

7 TEAM DOUBLE ELIMINATION

Allow 1 Hour And 45 Minutes For Racing

Team On Top On The Left

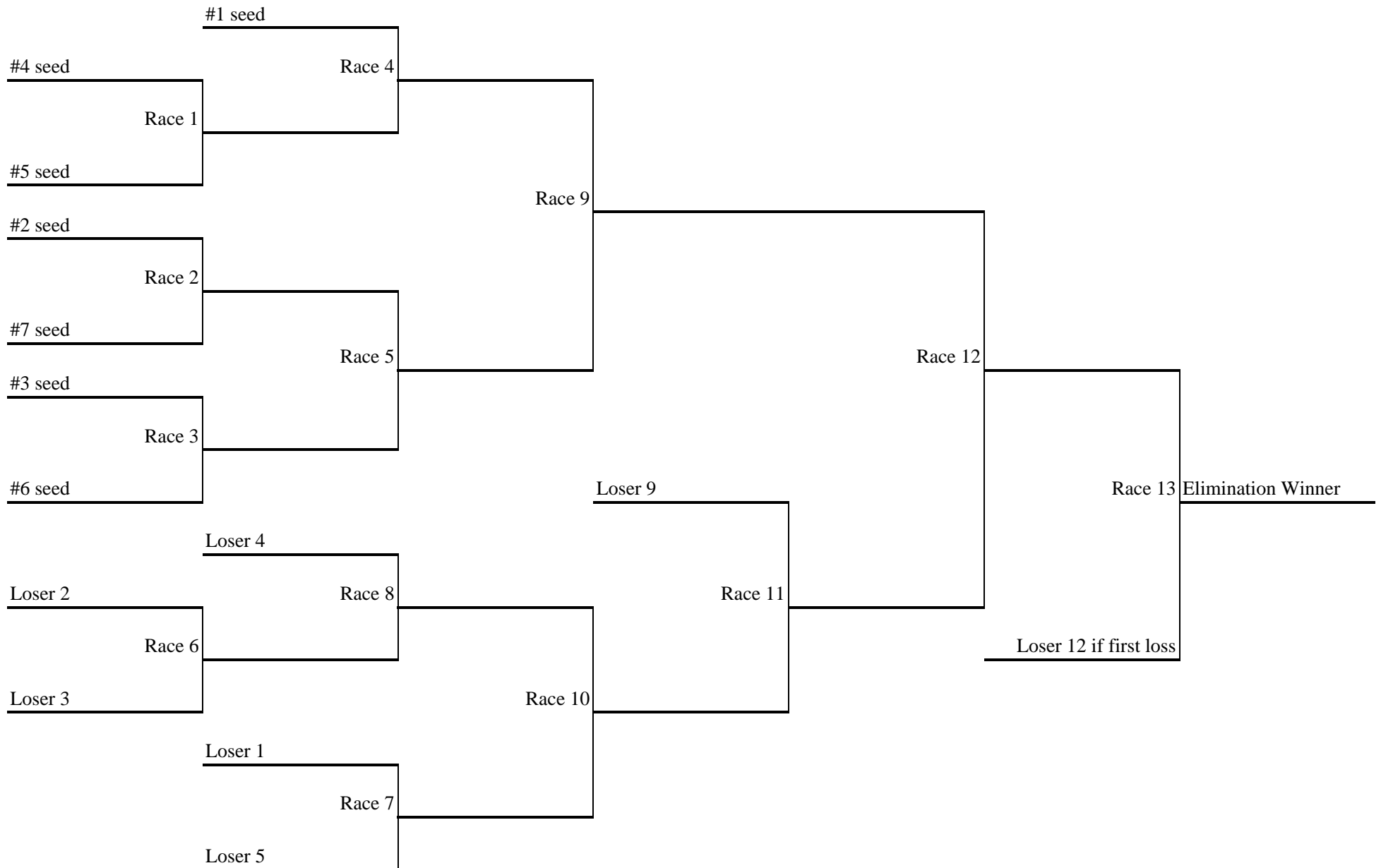

8 TEAM DOUBLE ELIMINATION

Allow 2 Hours For Racing
Team On Top On The Left

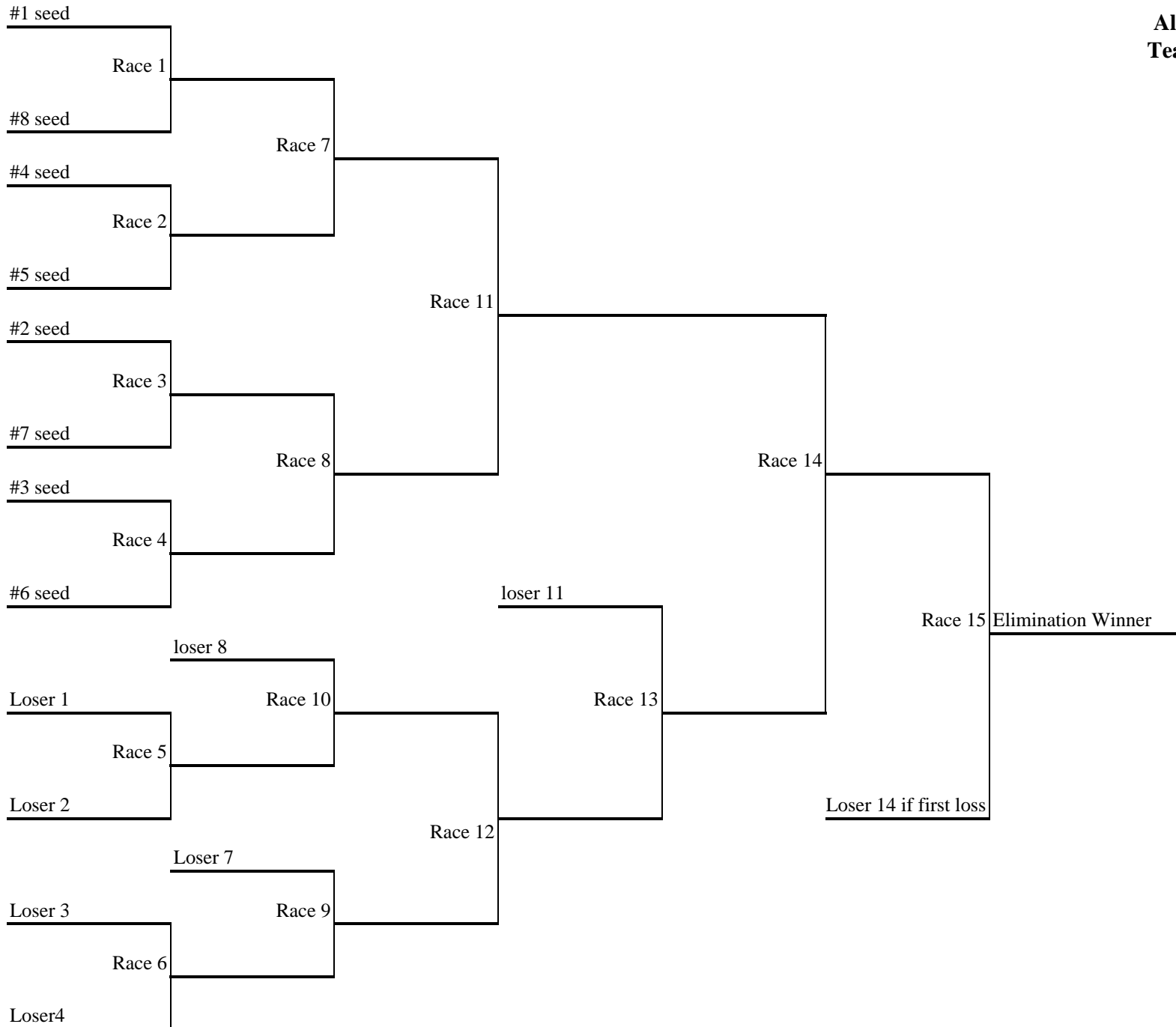

9 TEAM DOUBLE ELIMINATION

Allow 2 Hours And 20 Minutes For Racing

Team On Top On The Left

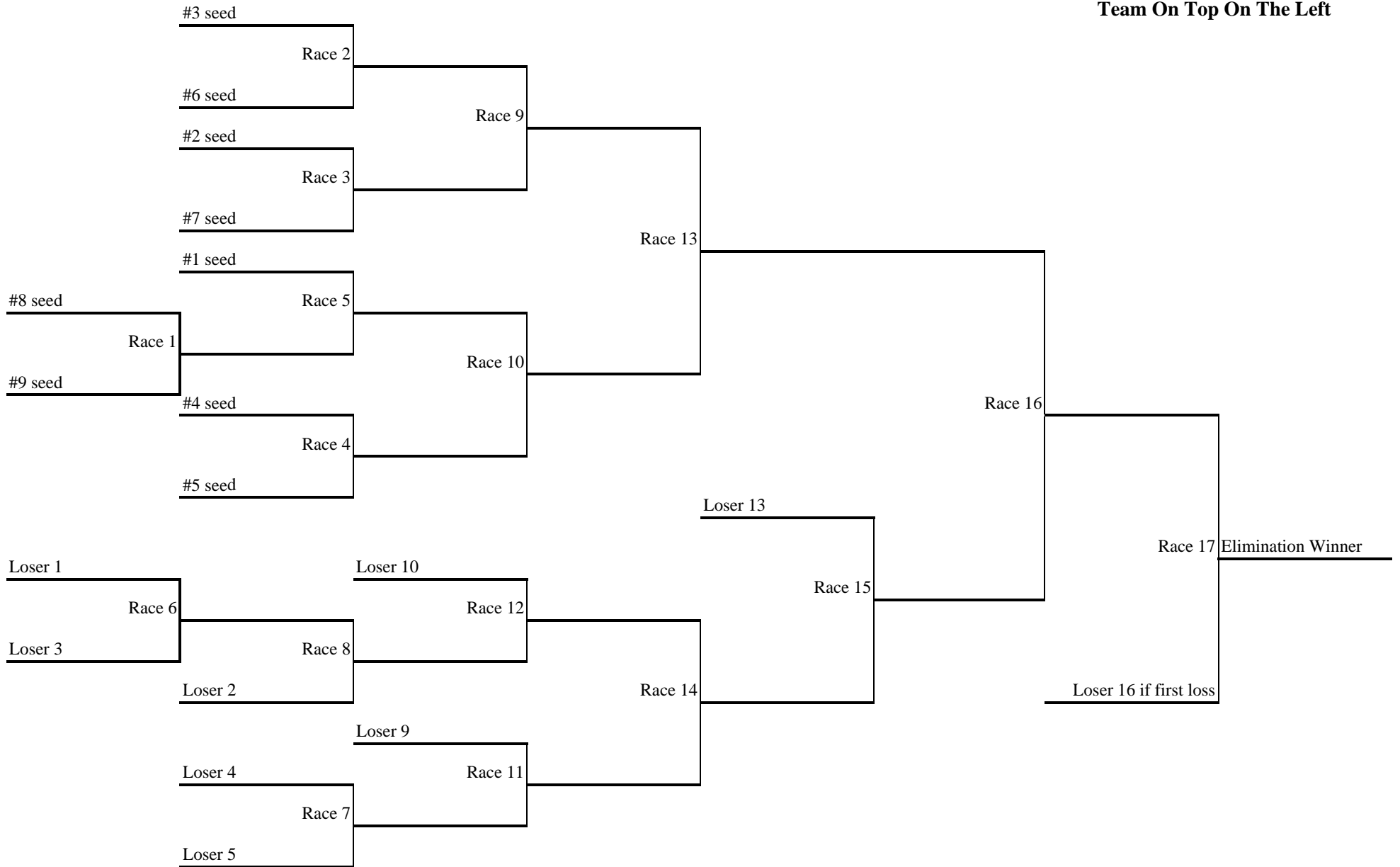

10 TEAM DOUBLE ELIMINATION

Allow 2 Hours And 40 Minutes For Racing

Team On Top On The Left

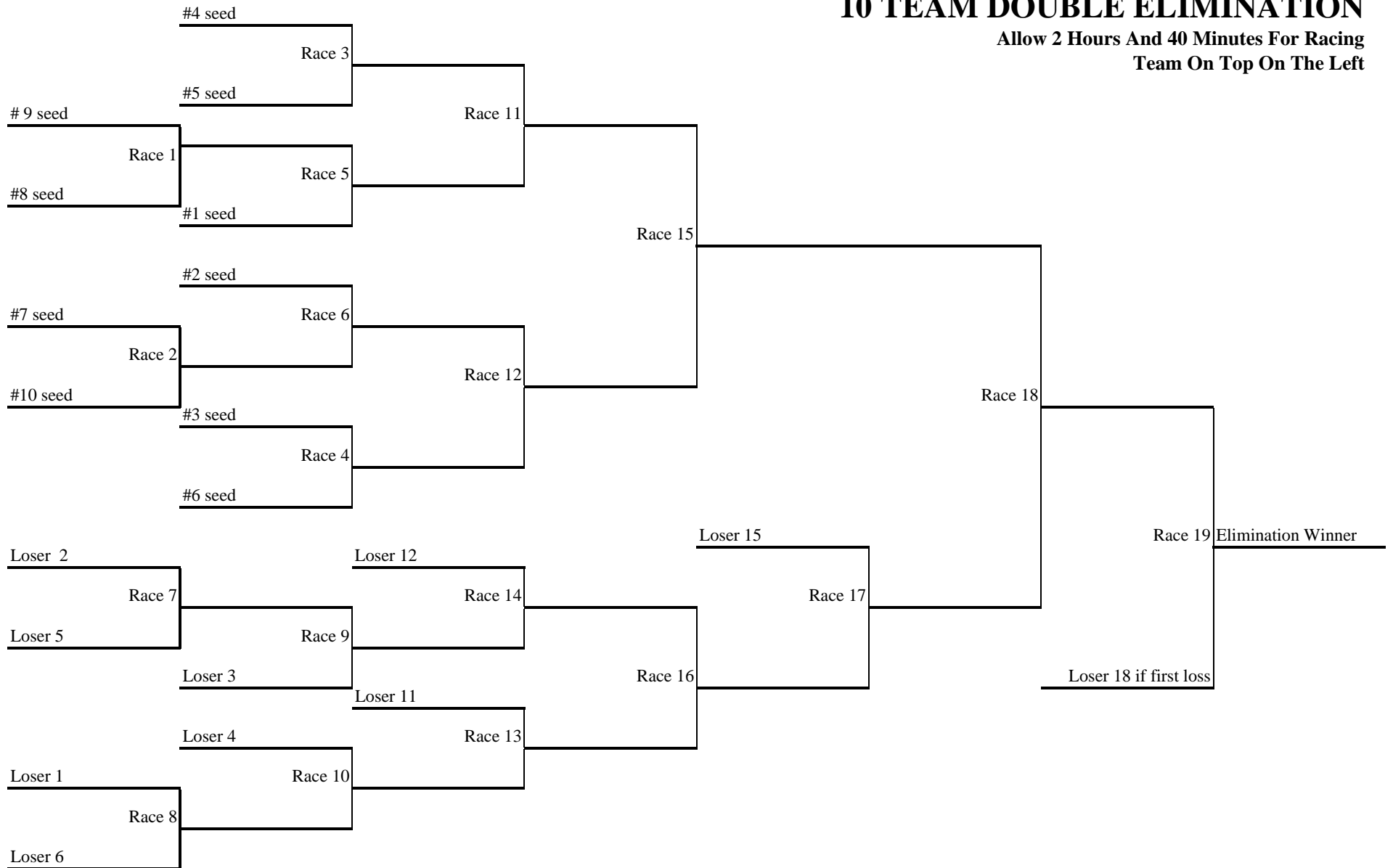

11 TEAM DOUBLE ELIMINATION

Allow 3 Hours For Racing
Top Team On The Left

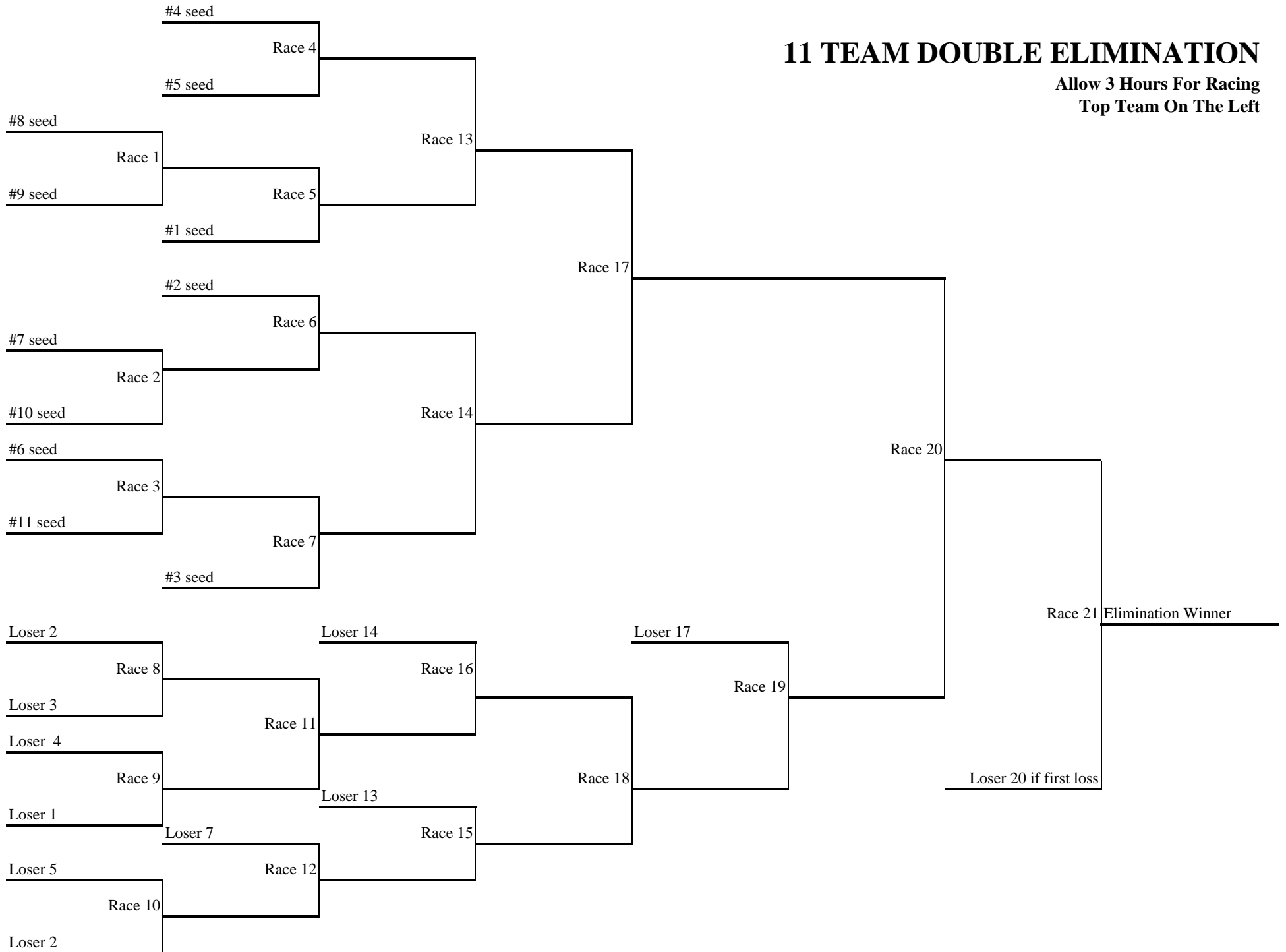

12 Team Double Elimination

Allow 3 Hours and 10 Minutes for Racing

Team On Top On The Left

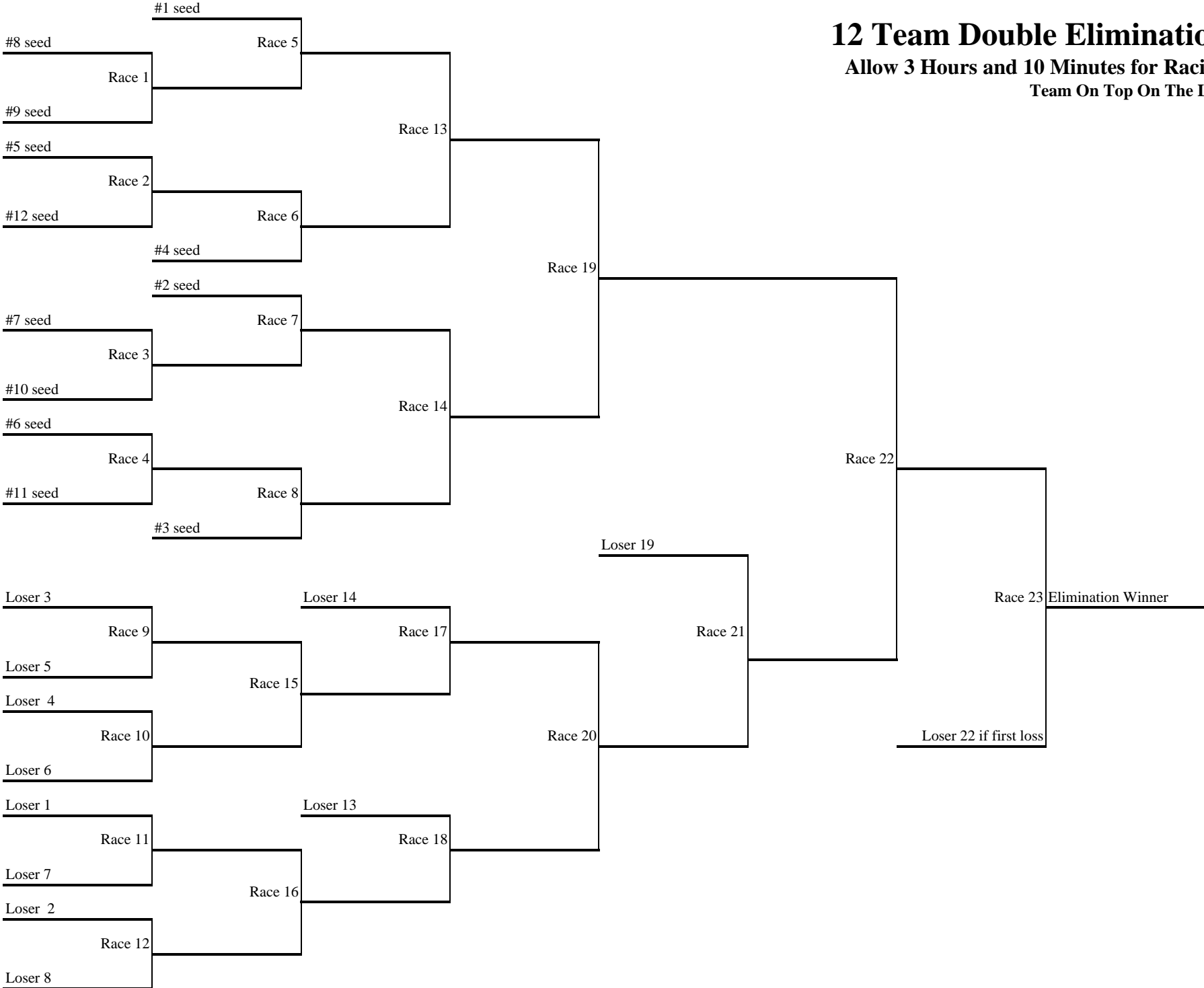

13 TEAM DOUBLE ELIMINATION

Allow 3 Hours and 30 Minutes For Racing

Top Team On The Left

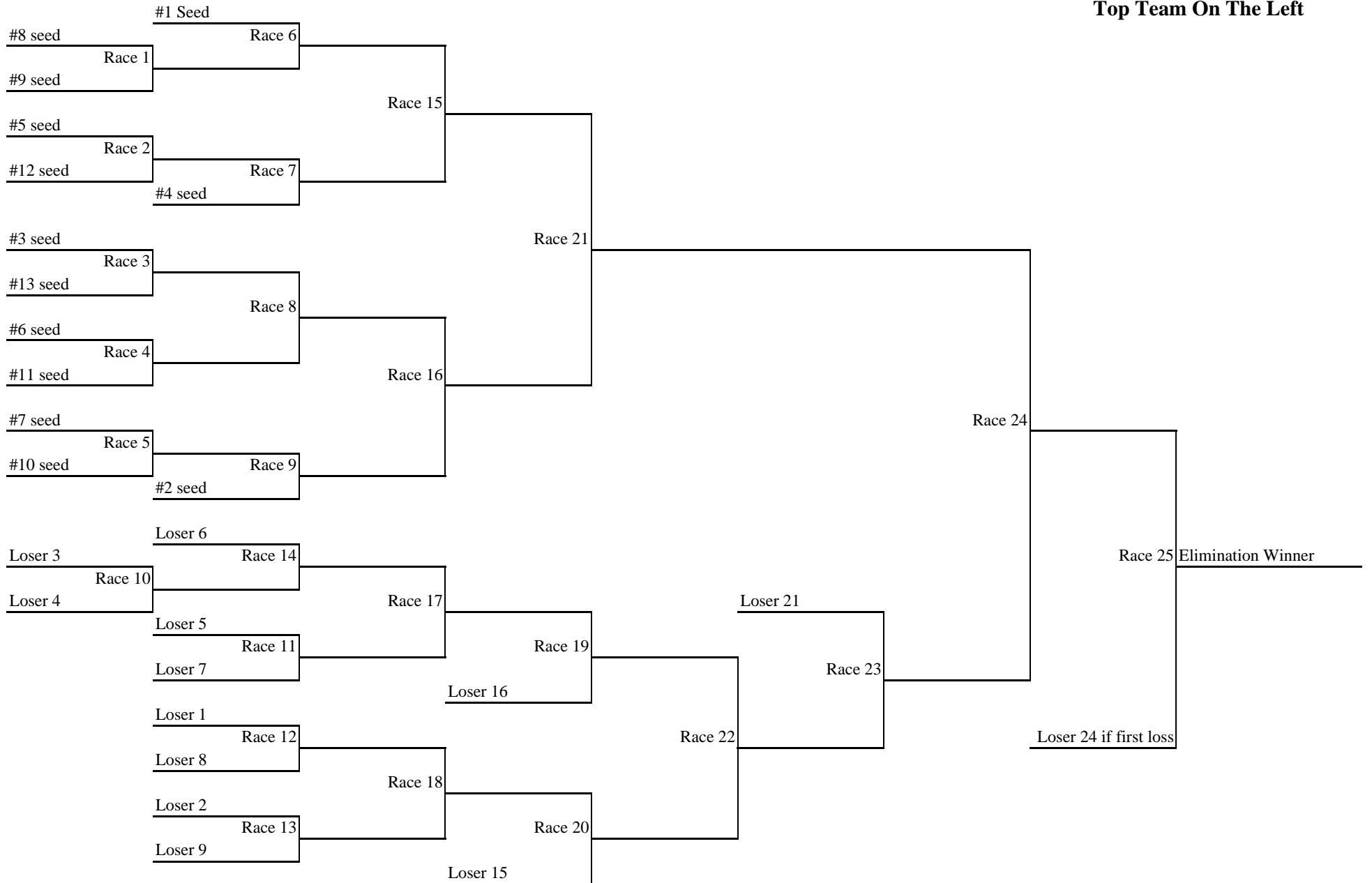

14 TEAM DOUBLE ELIMINATION

Allow 3 Hours And 45 Minutes For Racing

Team On Top On The Left

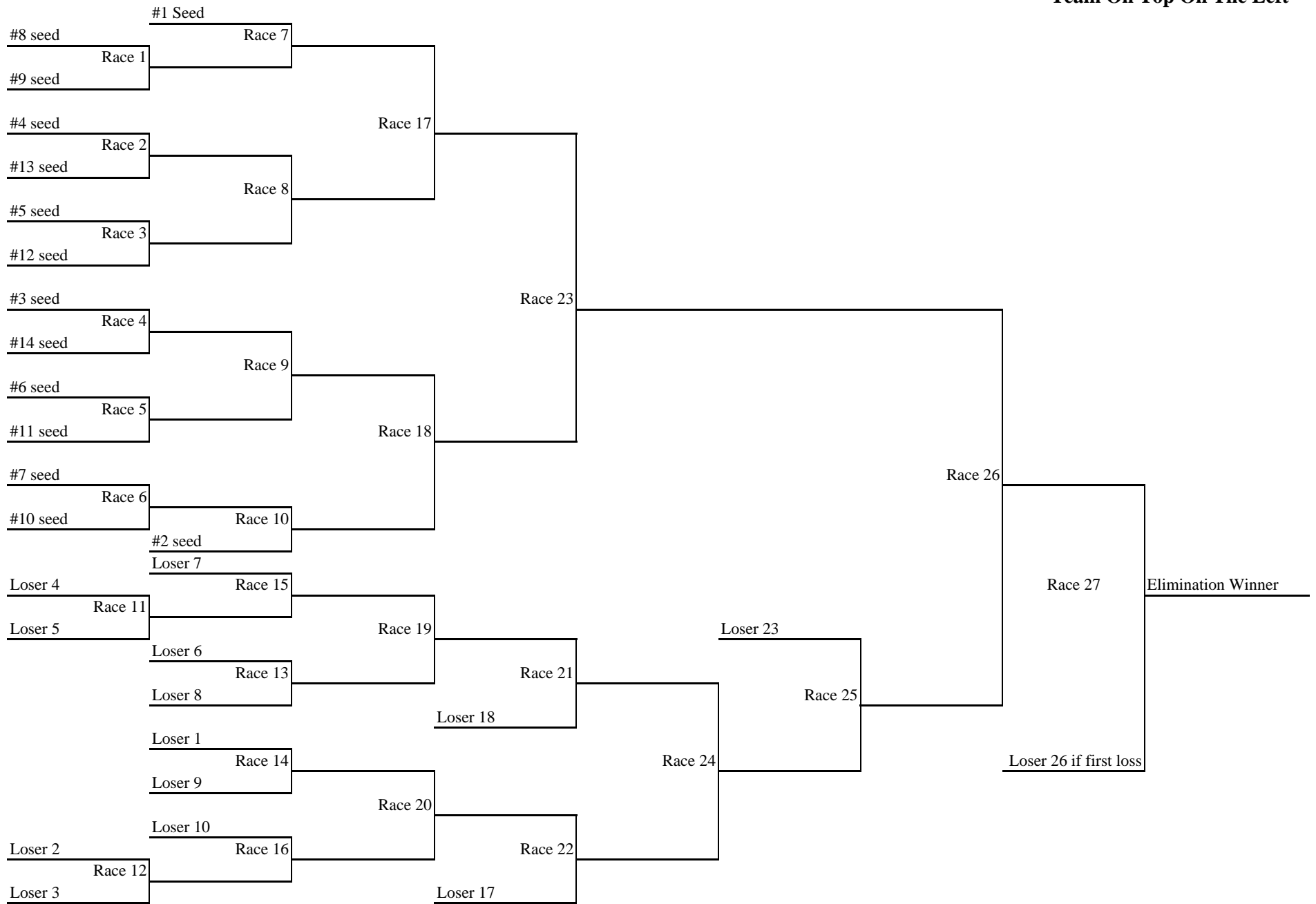

15 TEAM DOUBLE ELIMINATION

Allow 4 Hours For Racing
Team On Top On The Left

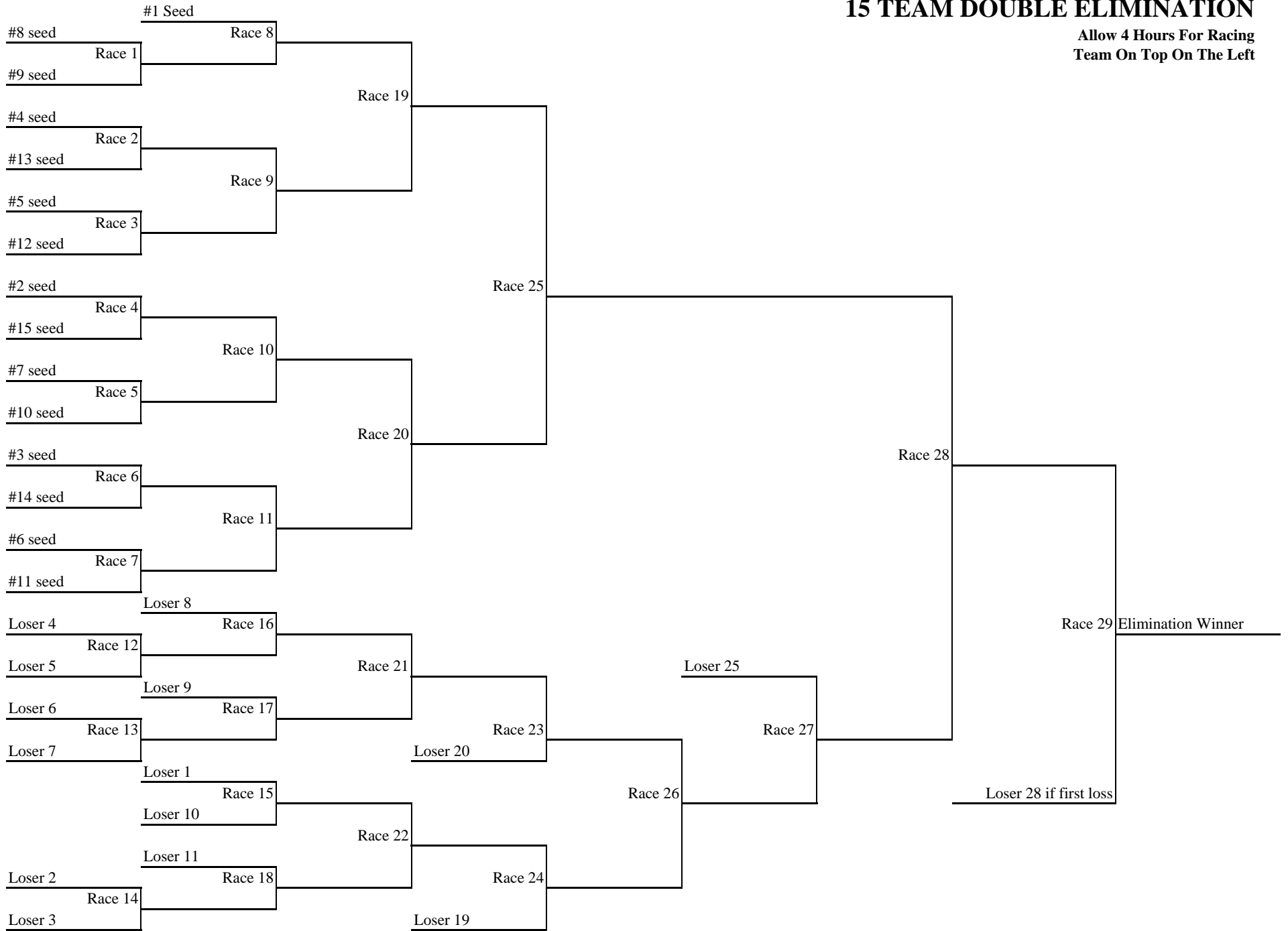

16 TEAM DOUBLE ELIMINATION

Allow 4 Hours and 20 Minutes For Racing
Team On Top On The Left

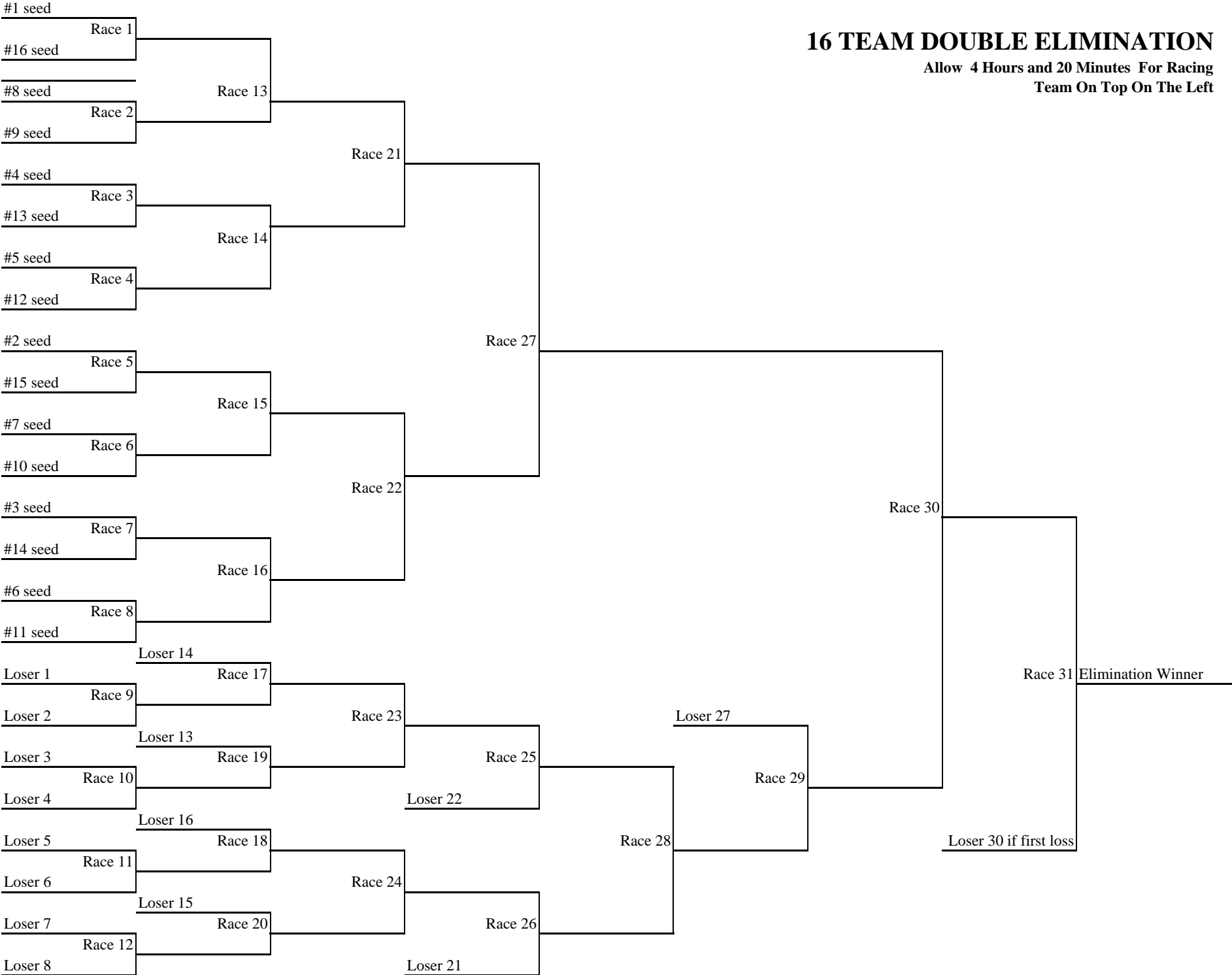

DOUBLE ELIMINATION PLACEMENTS

3 TEAM DOUBLE ELIMINATION

1ST Winner Race 5 (4)
2ND Loser Race 5
3RD Loser Race 3

4 TEAM DOUBLE ELIMINATION

1ST Winner Race 7 (6)
2ND Loser Race 7 (6)
3RD Loser Race 5
4TH Loser Race 4

5 TEAM DOUBLE ELIMINATION

1ST Winner Race 9 (8)
2ND Loser Race 9 (8)
3RD Loser Race 7
4TH Loser Race 6
5TH Loser Race 4

6 TEAM DOUBLE ELIMINATION

1ST Winner Race 11 (10)
2ND Loser Race 11 (10)
3RD Loser Race 9
4TH Loser Race 8
5TH Loser Race 6
6TH Loser Race 5

7 TEAM DOUBLE ELIMINATION

1ST Winner Race 12 (13)
2ND Loser Race 12 (13)
3RD Loser Race 11
4TH Loser Race 10
5TH Loser Race 7
6TH Loser Race 8
7TH Loser Race 6

8 TEAM DOUBLE ELIMINATION

1ST Winner Race 15 (14)
2ND Loser Race 15 (14)
3RD Loser Race 13
4TH Loser Race 12
5TH Loser Race 10
6TH Loser Race 9
7TH Loser Race 5
8TH Loser Race 6

9 TEAM DOUBLE ELIMINATION

1ST Winner Race 17 (16)
2ND Loser Race 17 (16)
3RD Loser Race 15
4TH Loser Race 14
5TH Loser Race 12
6TH Loser Race 11
7TH Loser Race 7
8TH Loser Race 8
9TH Loser Race 6

10 TEAM DOUBLE ELIMINATION

1ST Winer Race 19 (18)
2ND Loser Race 19 (18)
3RD Loser Race 17
4TH Loser Race 16
5TH Loser Race 14
6TH Loser Race 13
7TH Loser Race 9
8TH Loser Race 10
9TH Loser Race 8
10TH Loser Race 7

11 TEAM DOUBLE ELIMINATION

1ST Winner Race 21 (20)
2ND Loser Race 21 (20)
3RD Loser Race 19
4TH Loser Race 18
5TH Loser Race 15
6TH Loser Race 16
7TH Loser Race 12
8TH Loser Race 11
9TH Loser Race 10
10TH Loser Race 9
11TH Loser Race 8

12 TEAM DOUBLE ELIMINATION

1ST Winner Race 23 (22)
2ND Loser Race 23 (22)
3RD Loser Race 21
4TH Loser Race 20
5TH Loser Race 18
6TH Loser Race 17
7TH Loser Race 16
8TH Loser Race 15
9TH Loser Race 11
10TH Loser Race 9
11TH Loser Race 10
12TH Loser Race 12

DOUBLE ELIMINATION PLACEMENTS

13 TEAM DOUBLE ELIMINATION

1ST	Winner Race 25 (24)
2ND	Loser Race 25 (24)
3RD	Loser Race 23
4TH	Loser Race 22
5TH	Loser Race 20
6TH	Loser Race 19
7TH	Loser Race 17
8TH	Loser Race 18
9TH	Loser Race 14
10TH	Loser Race 13
11TH	Loser Race 12
12TH	Loser Race 11
13TH	Loser Race 10

14 TEAM DOUBLE ELIMINATION

1ST	Winner Race 27 (26)
2ND	Loser Race 27 (26)
3RD	Loser Race 25
4TH	Loser Race 24
5TH	Loser Race 22
6TH	Loser Race 21
7TH	Loser Race 19
8TH	Loser Race 20
9TH	Loser Race 15
10TH	Loser Race 16
11TH	Loser Race 14
12TH	Loser Race 13
13TH	Loser Race 12
14TH	Loser Race 11

15 TEAM DOUBLE ELIMINATION

1ST	Winner Race 29 (28)
2ND	Loser Race 29 (28)
3RD	Loser Race 27
4TH	Loser Race 26
5TH	Loser Race 23
6TH	Loser Race 24
7TH	Loser Race 21
8TH	Loser Race 22
9TH	Loser Race 16
10TH	Loser Race 17
11TH	Loser Race 18
12TH	Loser Race 15
13TH	Loser Race 14
14TH	Loser Race 13
15TH	Loser Race 12

16 TEAM DOUBLE ELIMINATION

1ST	Winner Race 31 (30)
2ND	Loser Race 31 (30)
3RD	Loser Race 29
4TH	Loser Race 28
5TH	Loser Race 26
6TH	Loser Race 25
7TH	Loser Race 23
8TH	Loser Race 24
9TH	Loser Race 19
10TH	Loser Race 20
11TH	Loser Race 18
12TH	Loser Race 17
13TH	Loser Race 10
14TH	Loser Race 12
15TH	Loser Race 11
16TH	Loser Race 9

4 Team Single Elimination

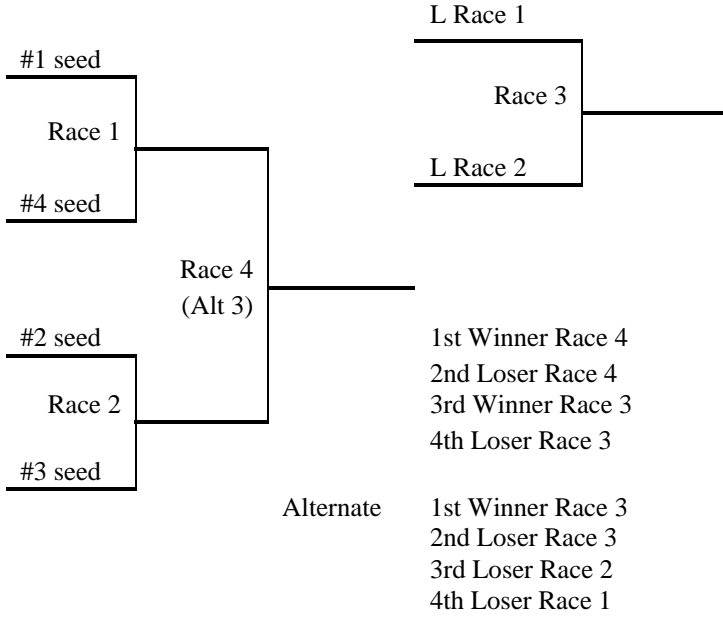

6 Team Single Elimination

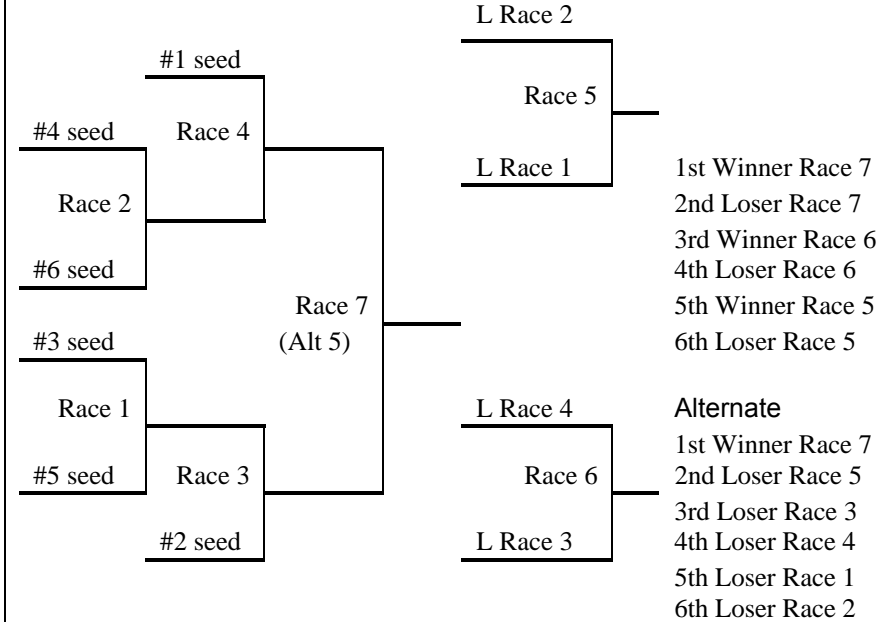

5 Team Single Elimination

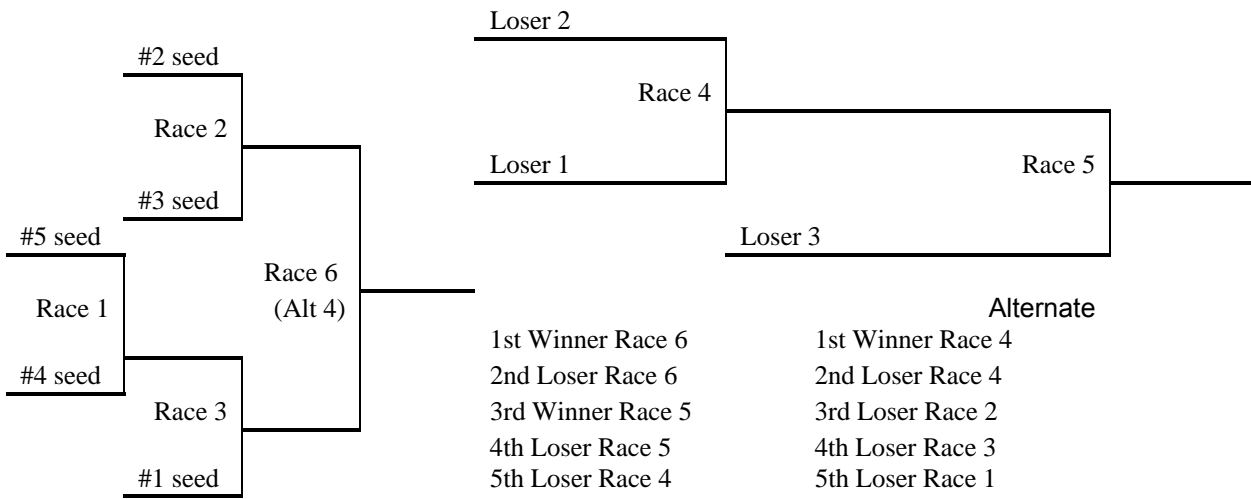

7 TEAM SINGLE ELIMINATION With Loser Races - All teams guaranteed 2 races

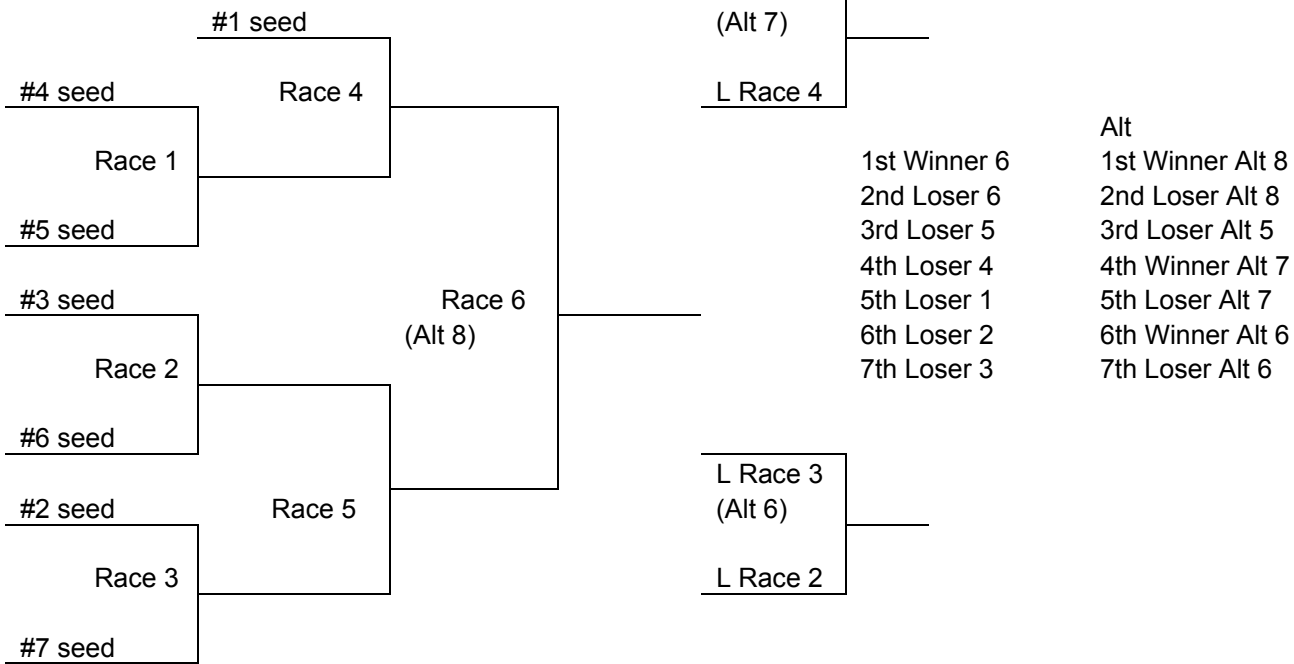

8 TEAM SINGLE ELIMINATION
With Loser Races - All teams guaranteed 2 races

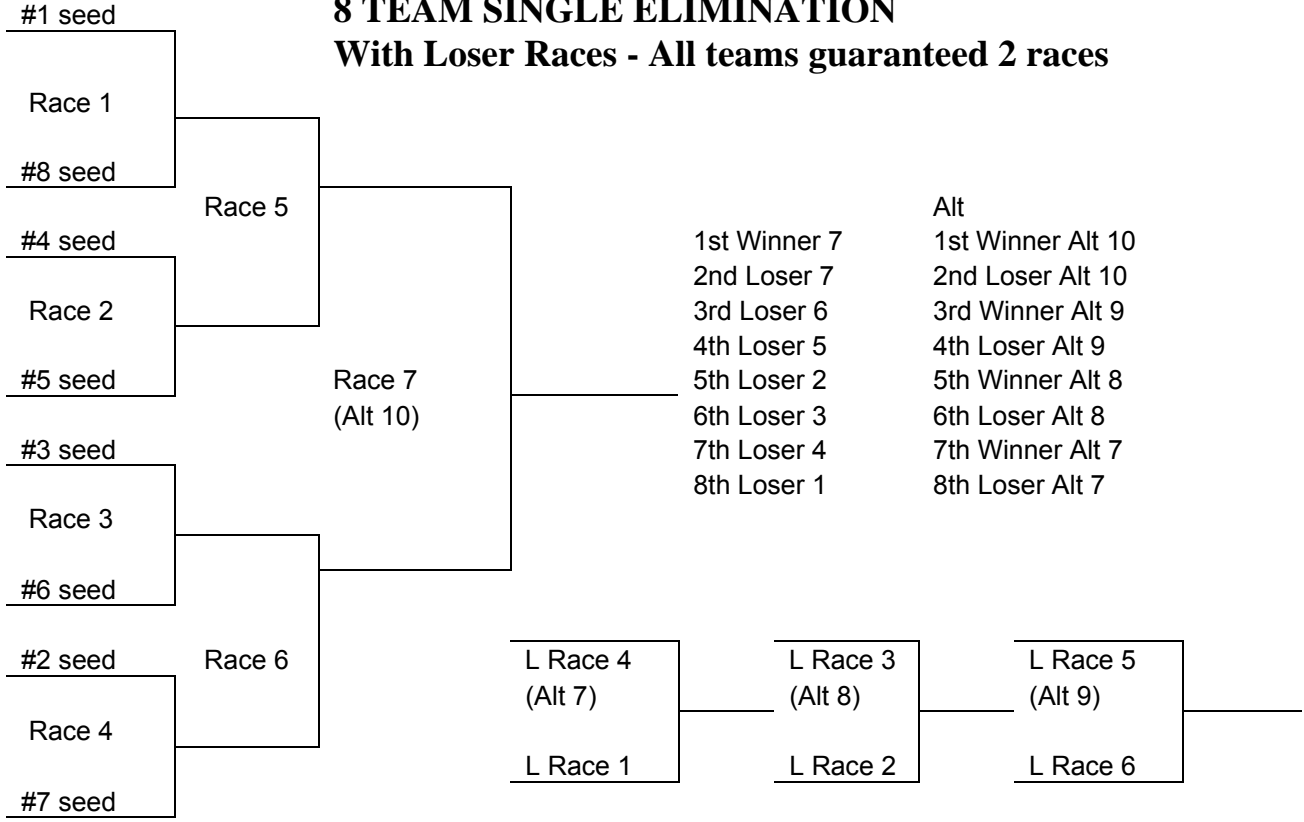

9 Team Single Elimination

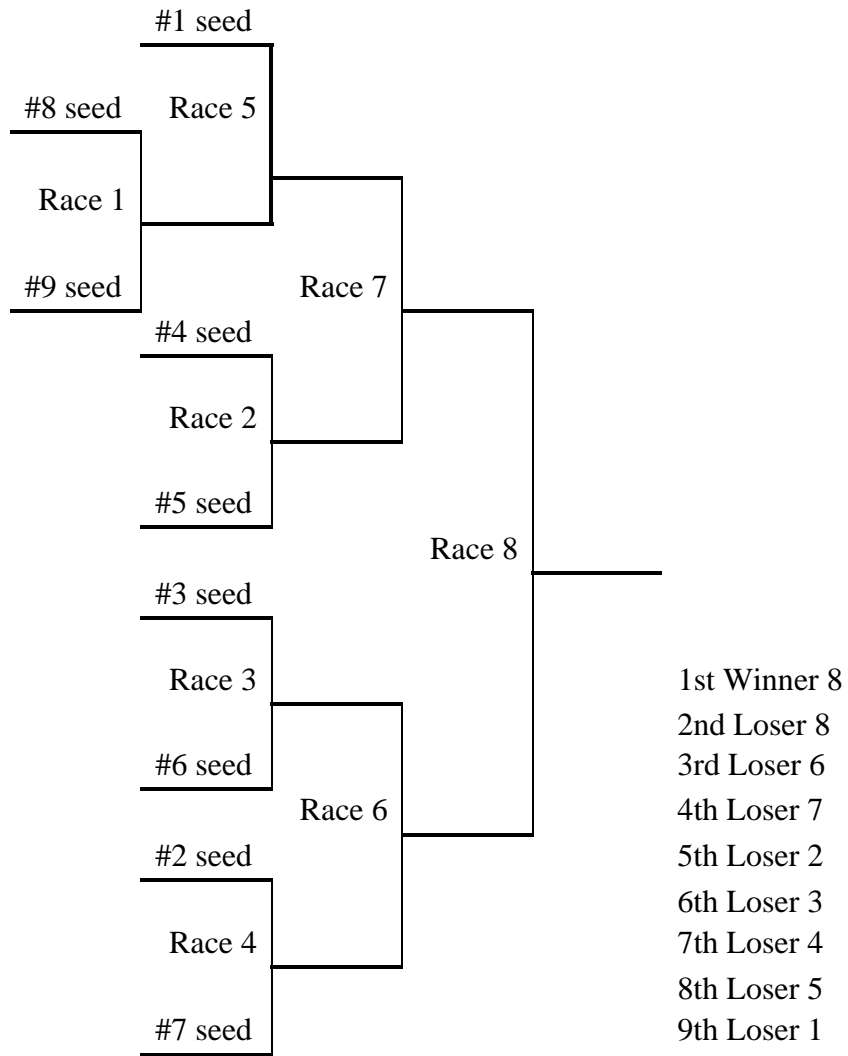

10 Team Single Elimination

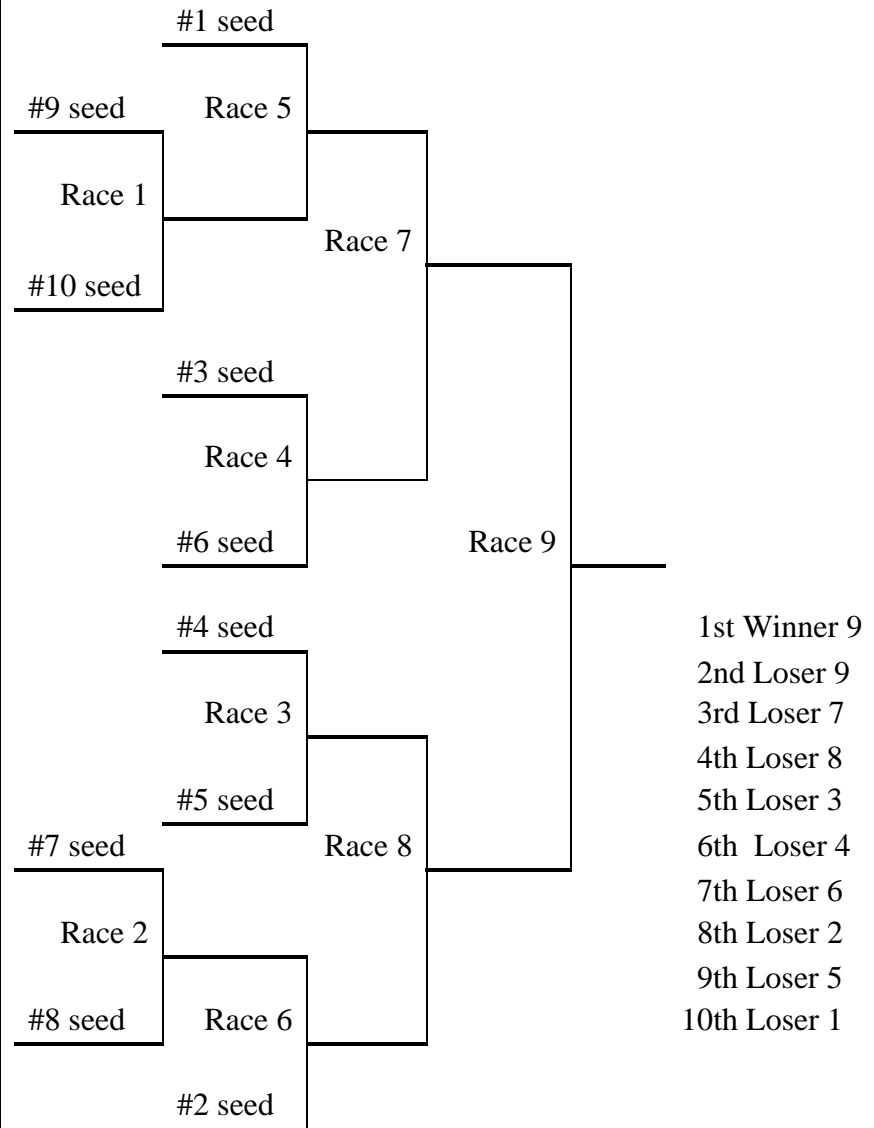

NORTH AMERICAN FLYBALL ASSOCIATION, INC.®

APPENDIX D

NAFA® Judges Training Program

NAFA® Judges Training Program

Introduction

The NAFA® Rules of Racing (RR) and Corporate Policies & Procedures (CPP) Manuals are designed to ensure fair and equal treatment for all competitors. As a NAFA® judge, you are authorized to enforce and uphold the rules within the NAFA® rulebook. As a representative of NAFA®, you are required to represent NAFA® in a positive manner while discharging your duties. Being friendly, courteous, diplomatic, fair and impartial are all required qualities necessary to represent NAFA®.

The Manual outlines numerous rules and policies that NAFA® judges need to ensure are adhered to, but there are two basic premises that all judges should keep in mind at all times:

- I. NAFA® is founded on fairness and sportsmanship! A judge must leave exhibitors and spectators with the feeling that each team was given an equal opportunity and no team was given an unfair advantage.
- II. The safety and well being of the dogs and exhibitors shall be foremost.

Code of Conduct

As a representative of NAFA®, a judge's behavior and appearance reflect upon NAFA®, the host club and the sport in general and should be professional at all times. Being professional includes, but is not limited to the following:

- The judge is expected to be friendly to all competitors.
- Questions posed by exhibitors or spectators should be answered thoroughly in a courteous and respectful manner.
- The judge should be sympathetic to the needs of the competitors, but firm in enforcing the Rules of Racing and Corporate Policies & Procedures of NAFA®.
- A judge must leave exhibitors and spectators with the feeling that each team was given an equal opportunity and no team was given an unfair advantage
- To prevent the perception of 'favoritism', the head judge should not wear any item that shows team affiliation during the discharge of their duties. (It is highly encouraged, but not required, that relief judges do not wear team apparel while judging.)
- A judge should refrain from engaging in heated debates with disgruntled exhibitors. At no time during a judging assignment, should a judge lose his or her temper with an exhibitor or use foul language with anyone.
- At no time during a judging assignment should a judge consume alcohol.

Requirements to Begin the Training Program

Initial requirements to begin the training program are:

1. The individual must be in good standing with NAFA®
2. The individual must be at least 18 years of age
3. The individual must possess a current copy of the NAFA® Rules of Racing and Corporate Policies & Procedures Manual

The individual should submit a completed form C.5 to the NAFA® Judges Committee to obtain approval to begin the Novice program. Assignment Evaluation Forms are located at C.16.

NOVICE JUDGE:

Overview:

During NAFA® sanctioned tournaments, any decisions rendered by a NAFA® approved judge are considered “Final” when they concern infractions that occurred during racing or are violations of the NAFA® Corporate Policies and Procedures. Managing that authority responsibly requires a thorough understanding of all duties of a NAFA® judge.

Novice Judges must be committed to learning the necessary information and skills before becoming a NAFA® Approved Judge.

Assignments:

- Box judging assignment
- Line judging assignment
- Observational assignment
- Measuring training
- Table assignment
- Completion of the exams

Box Judging:

The Novice Judge is required to box judge a minimum of 25 races under a Supervising or Approved Judge.

Learning objectives:

- Knowledge of the responsibilities of the Box Judge (*CPP Ch. 5 a – e*)
- Identification of all infractions signaled by the box judge (*CPP Ch. 8.3 a,c,e,i,k*)

Line judging:

The Novice Judge is required to line judge a minimum of 25 races under a Supervising or Approved Judge.

Learning objectives:

- Knowledge of the responsibilities of the Line Judge (*CPP Ch. 5 a-e, g*)
- Identification of all infractions signaled by the line judge (*CPP Ch. 8.3 a,b,i,l,m*)
- Familiarization with the C2 form and responsibilities of the line judge in relation to that form (*Appendix C*)

Observational assignment:

The Novice judge is required to observe a Supervising Judge perform the Head Judge duties for a minimum of 25 races.

Learning objectives:

- Set-up, function and testing of the Electronic Judging System (EJS)
- Ensuring all equipment is within expected standards (racing lanes, jumps and boxes) (*RR Ch. 1.1 b-e, 1.2, 2.2, 2.3 a-b, 2.4 a*)
- Familiarization of relationship between line judge, box judge, scoring table and head judge (*CPP Ch. 5 a-g*)
- Observation of interaction between the head judge and competitors
- Identification of infractions signaled by the Supervising Judge and how the action of the dog or handler being signaled violated the Rules of Racing (*RR Ch 6-8*)

Measuring training:

The Novice Judge is required to observe a Judge measure height dogs at three different tournaments over three different weekends. The first two measuring observations may be under a Supervising or Approved Judge, but the third must be performed under a Supervising Judge. The Novice Judge will demonstrate the ability to set up the wicket and practice measure (i.e. unofficial measures) a minimum of 5 dogs at each of these three assignments.

Learning objectives:

- Rules governing measuring (*RR Ch. 4*)
- Proper set-up of the wicket
- Identification of a proper stand as outlined in the NAFA® Rulebook (*RR Ch. 4 m*)
- Identification of the proper place on the dog (withers) to take the measurement (*RR Ch. 4 m*)
- Demonstrate a proper rapport with the dog being measured
- Ability to read the measurement labeled on the wicket obtained during measuring

Table Assignment:

The Novice Judge is required to work the scoring table for a minimum of 25 races under a Supervising or Approved Judge.

Learning Objectives:

- Familiarization with procedures used to record times for a tournament

- Familiarization with process of assigning times for heats when interference occurs (*RR Ch. 8.3 f*)
- Familiarization with a properly documented C2 form (*Appendix C*)
- Familiarization of the interaction between the scoring table and head judge

Judge's Examinations:

After completing the assignments lists above, the Novice Judge should submit the following to the NAFA® Judges Committee:

1. The completed C.16 indicating satisfactory completion of all assignments.
2. A list of all items/infractions that a line judge and box judge must observe for while carrying out their duties.
3. A written essay covering how to set-up the wicket and an explanation of what is considered an acceptable stand as described in the NAFA® Rules of Racing & Corporate Policies and Procedures Manual.

Upon receipt of the above items, the judges committee will forward the applicant the Novice Judge's Exam. A passing score on the exam is 80%.

Objective of the Novice Judge's Examination:

- Ensure that the Novice judge has a through knowledge of the NAFA® Rules of Racing & Corporate Policies and Procedures Manual and the duties of all judges working the ring at events sanctioned by the North American Flyball Association. (*RR Ch. 1 – 8*)

Criteria for advancement to Apprentice judge status:

The Novice judge will be promoted to the level of Apprentice judge upon satisfactory completion of all assignments. From the date of promotion, the Apprentice judge has one year to complete the Apprentice judge assignments and to apply for promotion to Provisional judge status.

Failure to complete any portion of the Novice Judge's training program to the satisfaction of the Judges Committee will result in additional assignments being required of the Novice Judge prior to promotion. The number and nature of the additional assignments are at the discretion of the Judge's Committee and will be designed to remediate any area of expertise deemed to be lacking by the Novice judge.

APPRENTICE JUDGE:

Overview

The Apprentice Judge is expected to have a thorough understanding of the duties of all judges working at a tournament and of the NAFA® Rules of Racing and Policies & Procedures Manual. Under the supervision of a NAFA® appointed Supervising Judge, the Apprentice Judge will demonstrate his or her knowledge of the rules and ability to apply them while judging a NAFA® sanctioned event.

Assignments:

- Judge a minimum of 25 races at three different tournaments on different weekends under a minimum of two different NAFA® Supervising Judges.
- Measure a minimum of 8 dogs at three different tournaments on different weekends under the supervision of two different NAFA® Supervising Judges.

Learning Objective:

- Ability to accurately set-up the wicket and measure dogs
- Ability to identify and signal infractions as outlined in the NAFA® Rules of Racing & Policies & Procedures Manual
- Ability to explain the nature of infractions to competitors
- Ability to control the racing ring
- Ability to interact appropriately with exhibitors
- Development of personal judging style

Evaluation procedure:

The Apprentice judge will be evaluated by the NAFA® Supervising judge on his or her ability to perform the functions of a NAFA® judge. At each assignment an evaluation form will be completed by the NAFA® Supervising Judge.

Criteria for Promotion to Provisional Status:

Once all assignments have been completed, the Apprentice judge will forward all appropriate forms and evaluations to the NAFA® Judges Committee for consideration of promotion to Provisional judge status. The committee will consider the application and make a recommendation to the NAFA® Board of Directors regarding promotion. The chairman of the Judges committee will notify the applicant of the decision of the NAFA® Board of Directors. If promotion occurs, the newly appointed Provisional judge has one year from the date of promotion to complete the Provisional judge assignments and apply for promotion to Approved judge status.

Failure to complete any portion of the Apprentice Judge's training program to the satisfaction of the Board of Directors will result in additional assignments being required of the Apprentice Judge prior to promotion. The number and nature of the additional assignments are at the discretion of the Board of Directors and will be designed to remediate any area of expertise deemed to be lacking by the Apprentice Judge.

PROVISIONAL JUDGE:

The Provisional Judge is to demonstrate the ability to perform the functions of a NAFA® Approved Judge without supervision.

Assignments:

- Judge a minimum of 25 races at three tournaments on 3 different weekends. Must judge a minimum of 40 races during one of those assignments.
- Must be the measuring judge at two tournaments on two different weekends and measure a minimum of 8 dogs at each tournament.
- Receive an evaluation by both the Regional Director & Tournament Director from each assignment

Learning Objective:

- Ability to perform the functions of a NAFA® Approved Judge without relying on the immediate input that is provided by a Supervising Judge.
- Establish a confident ring presence while managing the racing at a NAFA® sanctioned tournament.

Criteria for Promotion to Approved Status:

Once all assignments have been completed, the Provisional Judge will forward all appropriate forms and evaluations to the NAFA® Judges Committee for consideration of promotion to Approved Judge status. The committee will consider the application and make a recommendation to the NAFA® Board of Directors regarding promotion. The chairman of the NAFA® Judges Committee will notify the applicant of the decision of the NAFA® Board of Directors.

Failure to complete any portion of the Provisional Judge's training program to the satisfaction of the Board of Directors will result in additional assignments being required of the Provisional Judge prior to promotion. The number and nature of the additional assignments are at the discretion of the Board of Directors and will be designed to remediate any area of expertise deemed to be lacking by the Provisional Judge.